

VOLKSWAGEN

AKTIENGESELLSCHAFT



Workshop equipment
Manufactured by Snap-on





Principles and processes we apply to create value

Founded on our mission and beliefs, these are strategic processes we use daily to create value across Snap-on, with the strategic partners we embrace and in the acquisitions we make.

Our commitment to safety is unwavering. Since 2004, we have achieved a 94% reduction in our safety incident rate and we will continue our emphasis on safety as we move forward.

The serious professionals who use our productivity solutions demand superior quality. For over 95 years, Snap-on has been providing just that. Again in 2015, automotive technicians continued to rate Snap-on as the best brand in major product categories.

Through our legions of mobile stores, direct sales forces and distributors across the globe, we make thousands of daily contacts with professionals in their workplaces. Each of these contacts represents an opportunity to understand in depth our customers' wants and needs, which we believe provides Snap-on with an important strategic advantage.

We thrive on innovation. Our customer connection processes help us understand the needs, we make thousands of daily contacts with professionals in their workplaces. Each of these contacts represents an opportunity to understand in depth our customers' wants and needs, which we believe provides Snap-on with an important strategic advantage.

We apply a structured set of tools and processes to eliminate waste and improve our operations. RCI has been critical to our operating income improvements and will continue to be an important ingredient in our progress going forward.

3D Wheel aligner VAS 701 001

Unique feature!

Wireless system provides flexible installation and usage options. Patented digital camera tracking automatically adjusts to the height of the vehicle.

Time saving and more convenience during the complete alignment process. The operator has to do less working steps and can align more vehicles per day.

Maximized accuracy, repeatability and flexibility

- Only 2 cameras are required to record targets! Lower probability of failure and lower energy costs
- An integrated third camera permanently calibrates the system
- Self-calibrating multiple times a second
- Ultra high resolution cameras to image the four targets on the wheel
- 3-Camera design
- Easy installation and flexible configuration
- Professional results and high productivity
- Mobile control terminal and 27" flat-screen monitor
- Light weight targets
- Rim clamping range 11" - 22"
- Easy assembly - covers complete VAG car park from 1up to Crafter
- Pro42 user software: a high-resolution ICON-based software program, with integrated VAG procedures
- Complete and up-to-date vehicle specs (VAG and non-VAG vehicles)
- VAG specs updated via the VOLKSWAGEN Network
- Software includes numerous features designed to improve the efficiency and effectivity of the alignment technician, such as caster sweep, rolling radius, cross diagonal measurement, A-arm adjust, cradle adjust and EZ Toe for easy toe adjustment of points difficult to access

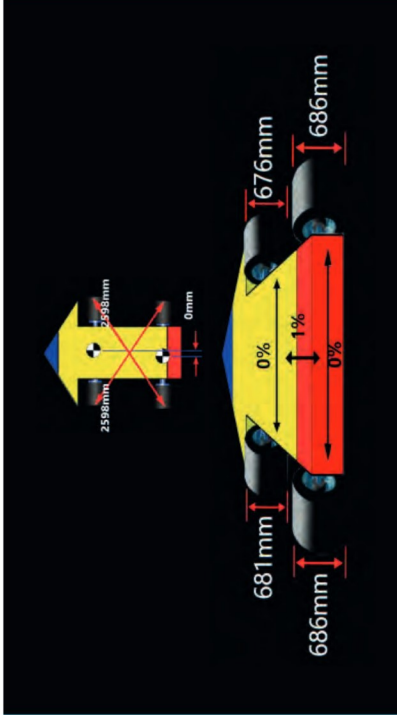
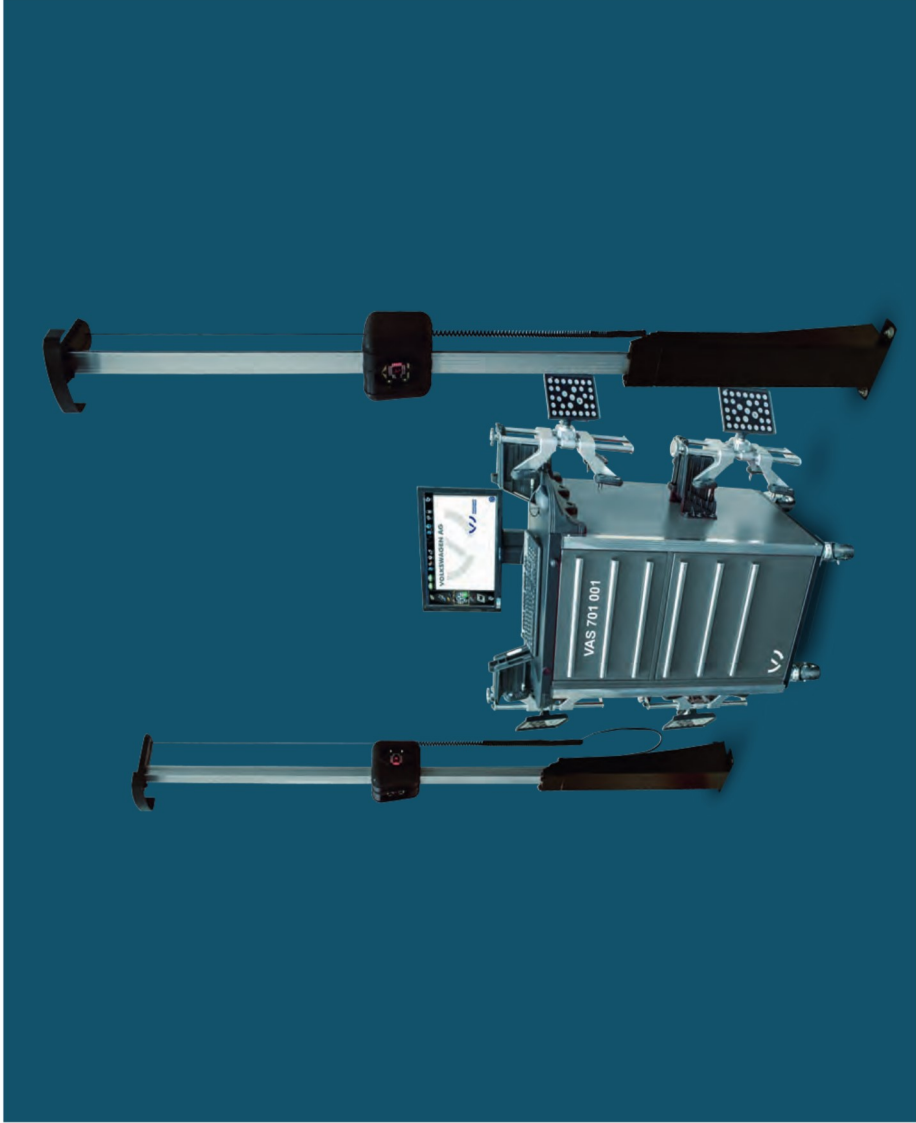

Get a complete picture of the condition of your vehicle in less than 2 Minutes!

VAS 701 001 is the only measuring device which measures vehicle dimensions during positioning:

- track width
- wheelbases
- diagonal distance between the wheel centers

are measured LIVE!

Prevents from incorrect alignment! - avoids the operator trying to align a damaged chassis.

Ride height measurement
Volkswagen AB requires ride height measurement for over 90% of their vehicles. VAS 701 001 is equipped with ride height measurement by using small targets (set of four) which can be easily attached to the wheel. The ride height is now measured without manual entry.
The targets are the same for all VAG vehicles and stored inside the cabinet.

Unique features:
Ride height targets are mounted by suction cups. This allows much faster and precise mounting.

Ride height targets are aligned via the aligner software - no spirit level is required.

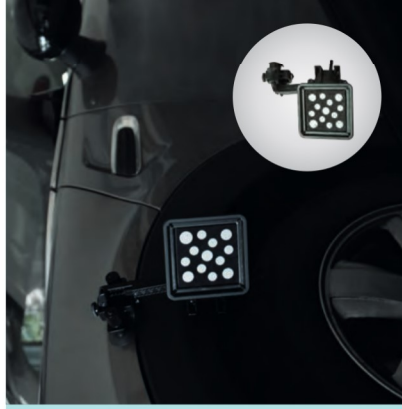

Driver assist specials VAS 701 001

Unique feature:

The VAS 6430 is aligned with VAS 701 001 to calibrate the front camera(s) in all parameters (e.g. distance, side to side offset, vertical rotation) with the support of the software.

No measuring tape necessary!

Faster, more precise and easier to use for the operator!



Installation layout

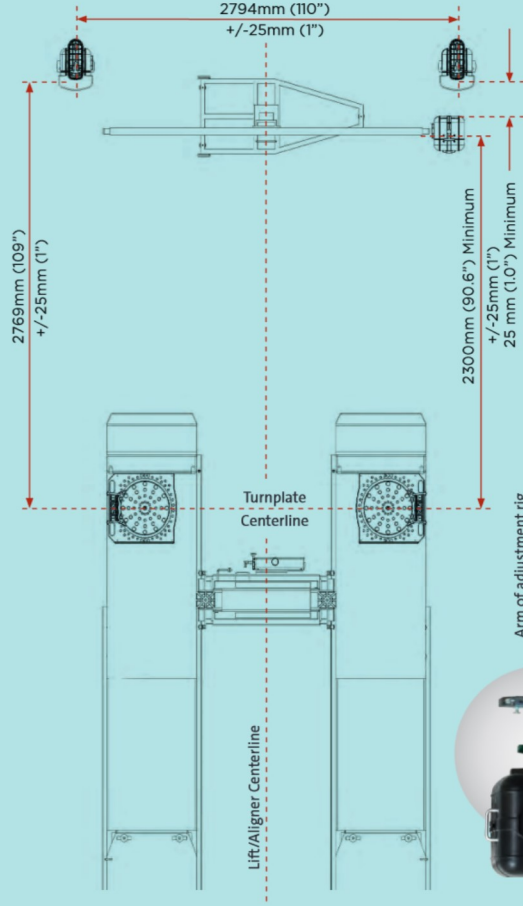

SELF-EXPLAINING SOFTWARE

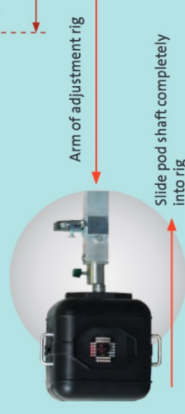

For the adjustment / calibration of assistance systems, only one additional camera on VAS 6430 (control camera) is necessary which can be used left or right to the direction of travel of the vehicle – measuring procedure is faster, allowing operators to measure more vehicles per day.

The control camera does not need to be leveled - saves time!

Camera for preparation of calibration of driver assist functions- VAS 701 001/1. Simple mounting to the VAS 6430.

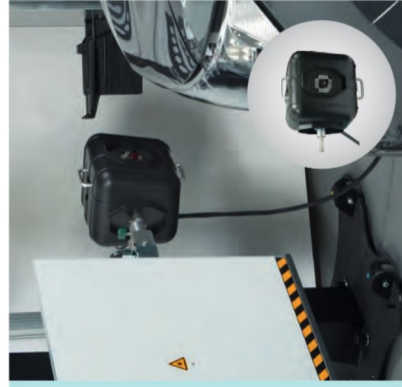

With VAS 701 001 the position of the VAS 6430 is permanently monitored during the calibration/adjustment of the ADAS. Changes in the travel axis or distances of the VAS 6430 to the vehicle are immediately displayed to the operator (optically & acoustically)

Unique feature!

Value for the customer: Each lift on the market has a different height. With VAS 701 001 the operator only has to enter the lift height into the software ONCE. The VAS 701 001 calculates by itself the correct height of the VAS 6430!
Fast, reliable, accurate!



Unique features:

Plausibility Check

Working with new, sophisticated, multiple suspensions in modern vehicles the accuracy of measurement becomes more important.

To check easily and make sure day by day that your wheel aligner is working properly and according to the given specs use the plausibility check function. This unique software feature enables the operator to check wheel aligner and environment. On customer request the operator can submit a test report.

Integrated in the software and self-explanatory.

- Helps you to easily meet the VAG alignment requirements!

Your Advantage:

- No other machine on the market can check and address the complete alignment surrounding
- Issues easily identified
- Saves a lot of time in your daily work
- Almost NO come-backs to the garage
- No more customer complaints
- Perfect control of the aligner

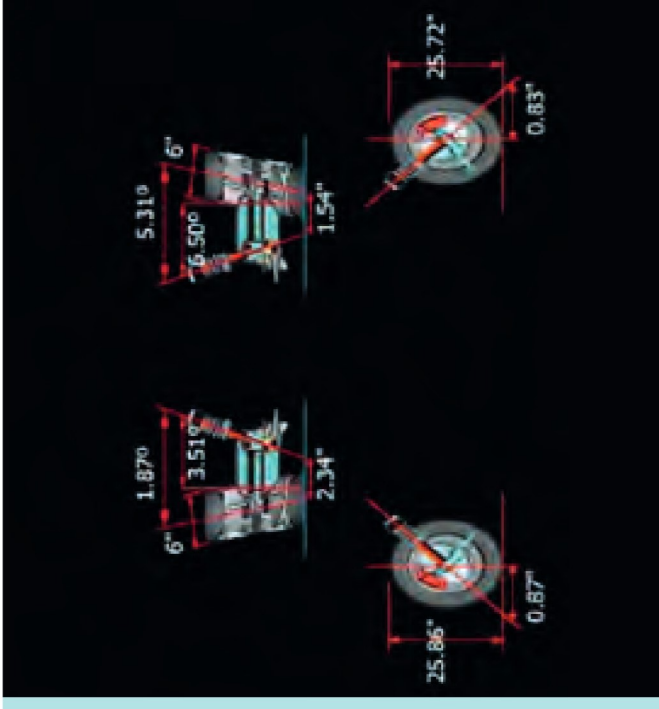

Live caster measurement

No additional program is required to adjust the caster. The only wheel alignment with which the caster is measured as a real angle and is permanently available as a "live" angle during the setting.

During swing procedure the scrub radius and caster trail are also measured. Scrub radius or its change (rim modifications with different offset) has a direct influence on the driving behaviour of modern vehicles and can be diagnosed with VAS 701 001.

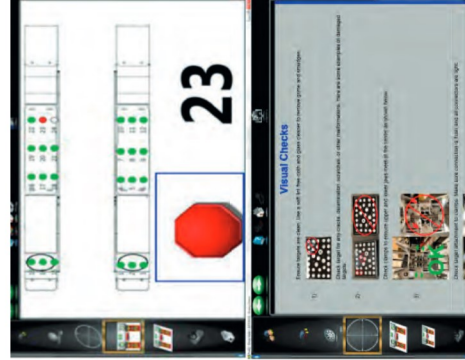

Rack Check - check the complete working area!

Check all points that could negatively influence the accuracy and repeatability of measurement:

- Rack
- Hardware parts
- Turnplates
- Surroundings

Both features integrated in the software and self-explanatory.

- Assures that the aligner works properly
- Saves service, time and money
- Prevents bad alignments!



Mobility kit

Very flexible system in combination with the mobility kit.

Unit can be removed and re-positioned - does not need to be re-calibrated

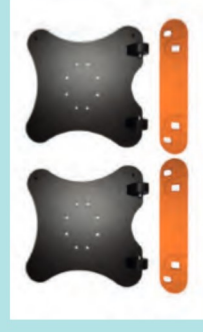

Wheel balancers

Balancing technology at its finest

VAS 6311A



Wheel diagnostics made easy - completely automatic with diagnostics features

- Five hi-res 3D imaging technology cameras scan the entire wheel and rim profile including tread surface, sidewall, bead seat and rim flange
- VPM measurement technology for uncompromised accuracy
- Power Clamp™, unique torque-controlled wheel clamping
- Automatic acquisition of rim diameter, rim width and offset
- Automatic selection of balancing mode and weight position
- Automatic detection of number and position of spokes
- Radial and lateral run-out combined with unbalance measurement in a single fast measuring run
- Tyre pull effect (tyre conicity)
- Tread depth and wear analysis
- Tyre wear-out prediction
- Alignment pre-checking
- All diagnostic results in brilliant 3D colour maps

VAS 6311A	
Rim centre bore diameter	mm 43–116
Measuring speed	rpm > 200
Input:	inch 1–20 (3–15.8)
	inch 8–32
	inch 8–32
Max. wheel width	mm 508
Max. wheel diameter	mm 950
Max. wheel weight	kg 70
Dimensions (W x D x H)	mm 1450x990x1710
Weight	kg 210
Power supply	230V, 1 ph / 50/60 Hz

VAS 741 029

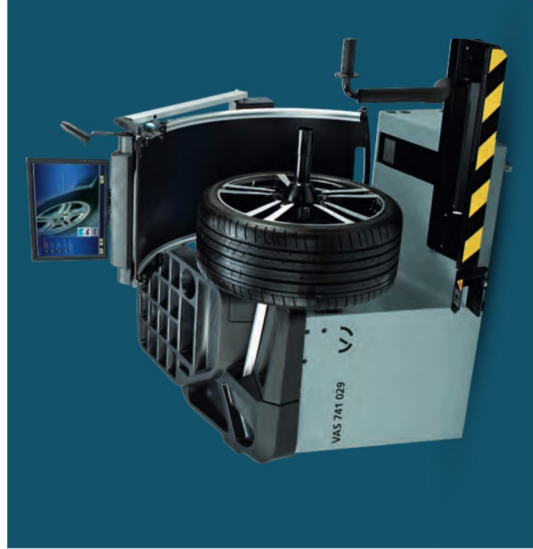

Car wheel balancer with non-contact data entry and diagnostic functions

- Radial run-out combined with unbalance measurement in a single fast measuring run
- VPM measurement technology for uncompromised accuracy
- Power Clamp™, unique torque-controlled wheel clamping
- Offset and diameter acquisition via laser scanner
- Rim width acquisition via Smart Sonar™
- Automatic selection of balancing mode and weight position
- Stop-in-Position: touch the display and the wheel goes to weight-placement position
- easyWEIGHT™, a laser spot shows exactly where to place the weight
- The telescopic wheel guard allows the installation against the wall
- Bright rim illumination thanks to iLED™
- Split weight mode, weight minimization and optimization
- Network: printing capability, compatible with asanetwork

VAS 741 029		
Rim centre bore diameter	mm	43–116
Measuring speed	rpm	> 200
Input:		
– Rim width (auto.)	inch	1–20 (3–15.8)
– Rim diameter auto.	inch	14–26
– Rim diameter man.	inch	8–32
Max. wheel width	mm	508
Max. wheel diameter	mm	1050
Max. wheel weight	kg	70
Dimensions (W x D x H)	mm	1940x1020x1570
Weight	kg	183
Power supply		230V, 1 ph / 50/60 Hz

VAS 741 019 (VAS 741 017)

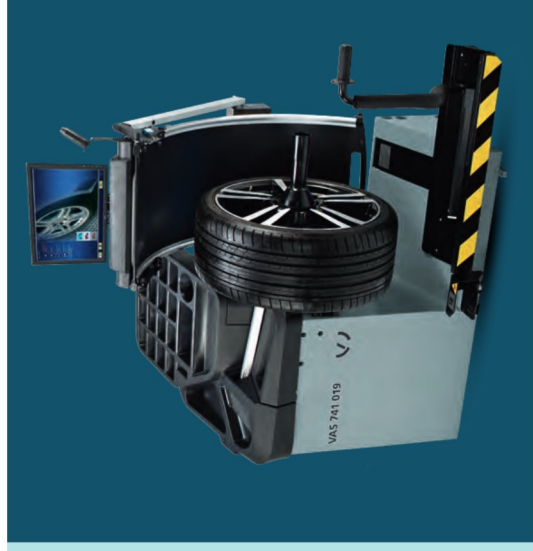

Wheel balancer with touchscreen monitor

- VPM measurement technology for uncompromised accuracy
- Power Clamp™, unique torque-controlled wheel clamping
- Offset and diameter acquisition via laser scanner
- Rim width acquisition via Smart Sonar™
- Wheel lift included
- Automatic selection of balancing mode and weight position
- Stop-in-Position: touch the display and the wheel goes to weight-placement position
- easyWEIGHT™, a laser spot shows exactly where to place the weight
- The telescopic wheel guard allows the installation against the wall
- Bright rim illumination thanks to iLED™
- Split weight mode, weight minimization and optimization
- Network: printing capability, compatible with asanetwork
- VAS 741 017: version without integrated wheel lift.
- Dimensions (W x D x H): 1380 x 1020 x 1570 mm, Weight: 135 kg

VAS 741 019		
Rim centre bore diameter	mm	43–116
Measuring speed	rpm	> 200
Input:		
– Rim width (auto.)	inch	1–20 (3–15.8)
– Rim diameter auto.	inch	14–26
– Rim diameter man.	inch	8–32
Max. wheel width	mm	508
Max. wheel diameter	mm	1050
Max. wheel weight	kg	70
Dimensions (W x D x H)	mm	1940x1020x1570
Weight	kg	170
Power supply		230V, 1 ph / 50/60 Hz

VAS 741 059 (VAS 741 057)

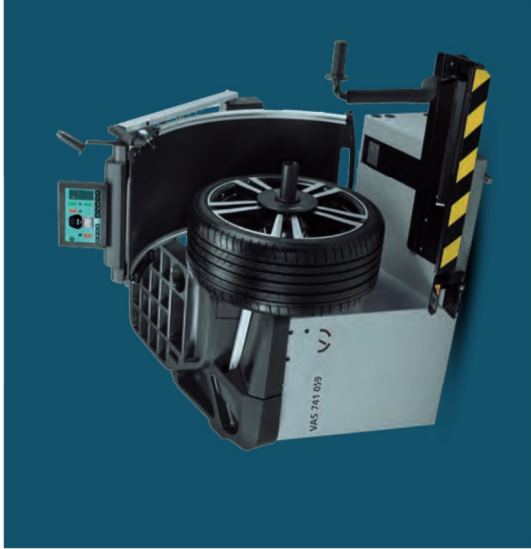

Wheel balancer with geoTOUCH™ display

- VPM measurement technology for uncompromised accuracy
- geoTOUCH™ display
- Power Clamp™, unique torque-controlled wheel clamping
- Offset and rim diameter acquisition via geodata® gauge arm
- Rim width acquisition via Smart Sonar™
- Wheel lift included
- Pre-selection of balancing mode via easyALU™
- Stop-in-Position: touch the display and the wheel goes to weight-placement position
- easyWEIGHT™, a laser spot shows exactly where to place the weight
- Bright rim illumination thanks to iLED™
- Split weight mode, weight minimization and optimization
- The telescopic wheel guard allows installation against the wall
- Network: printing capability, compatible with asanetwork
- VAS 741 057: version without integrated wheel lift.
- Dimensions (W x D x H): 1380 x 1020 x 1570 mm, Weight: 135 kg

VAS 741 059	
Rim centre bore diameter	mm 43–116
Measuring speed	rpm > 200
Input:	
– Rim width (auto.)	inch 1–20 (3–15.8)
– Rim diameter auto.	inch 8–30
– Rim diameter man.	inch 8–32
Max. wheel width	mm 508
Max. wheel diameter	mm 1050
Max. wheel weight	kg 70
Dimensions (W x D x H)	mm 1380x1020x1570
Weight	kg 170
Power supply	230V, 1 ph / 50/60 Hz

VAS 741 055



Car wheel balancer with geoTOUCH™ display

- VPM measurement technology for uncompromised accuracy
- geoTOUCH™ display
- Power Clamp™, unique torque-controlled wheel clamping
- easyWEIGHT™, a laser spot shows exactly where to place the weight
- Offset and diameter acquisition via 2D SAPE
- Rim width acquisition via Smart Sonar™
- Pre-selection of balancing mode via easyALU™
- QuickBAL™: short start-stop cycle: 4.5 seconds (15" rim)
- Stop-in-Position: touch the display and the wheel goes to weight-placement position
- Split weight mode, weight minimization and optimization
- Two users with rapid switch function
- Network: wifi connectivity, printing capability, compatible with asanetwork

VAS 741 055	
Rim centre bore diameter	mm 43–116
Measuring speed	rpm > 200
Input:	
– Rim width (auto.)	inch 1–20 (3–15)
– Rim diameter auto.	inch 8–25
– Rim diameter man.	inch 8–32
Max. wheel width	mm 508
Max. wheel diameter	mm 1050
Max. wheel weight	kg 70
Dimensions (W x D x H)	mm 1838x878x1834
Weight	kg 140
Power supply	230V, 1 ph / 50/60 Hz

Tyre changers wdk certified for best performance

VAS 6616

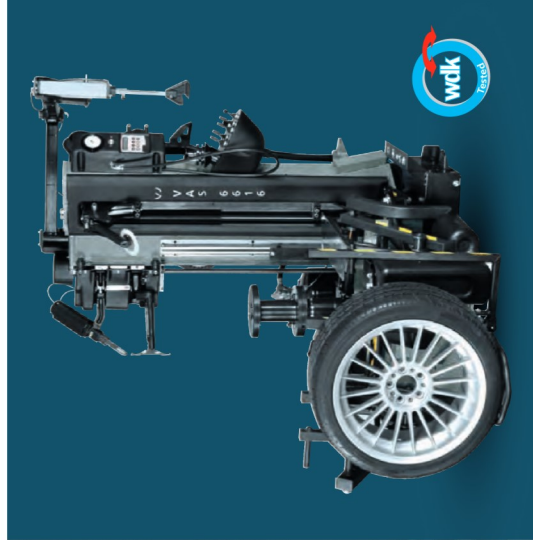

Automatic tyre changer with dynamic bead breaking

- Thanks to dynamic procedures and controlled power, all tyre changing operations are accomplished efficiently by preserving tyres and rims and reducing operator effort.
- Non-contact detection of rim contour by a laser scanner.
- Automatic control of mounting and demounting tools from the control console.
- Thanks to the lift, lift the wheels are positioned on the clamping flange automatically, accurately and say instead without operator effort.
- Hydraulic clamping of wheel on the clamping flange via quick-clamping nut.
- Rotating bead breaker discs gently follow the rim contour when breaking tyre beads.
- Tools specially designed for gentle handling of tyre and rim.
- The control console is located at an ideal level for convenient control and monitoring of the individual work steps.

VAS 6616

Inner clamping range	inch	12 – 26
Outer clamping range	inch	-
Max. rim width	inch	16
Max. tyre width	inch	17
Max. wheel diameter	mm	1200
Max. wheel weight	kg	70
Max. bead breaking width	mm	-
Dimensions (W x D x H)	mm	1290/1350x2240x1850
Weight	kg	820
Compressed air supply	bar	8 – 12
Power supply		230 V 1ph 50/60 Hz
Chuck speed	rpm	7 / 14

smartSpeed™

smartSpeed™ is the innovative technology applied to Tyre Changers that optimizes the torque and maximizes the rotation speed. Tyres are always more sophisticated and more difficult to change. The "Danger zone" is the area where the bead can easily be damaged during the mounting procedure if the operator does not take care. The danger zone is where the traction point is applying maximum stress to the tire during dismounting. Skilled operators know to reduce speed in the danger zone to avoid tire damage.

SAFE: No damage to tyres: continuous control of the chuck torque avoiding to exceed 1.200 Nm
FAST: This technology automatically selects the maximum speed possible: chuck rotation up to 20 rpm
EASY TO USE: Operators simply press the pedal and smartSpeed™ automatically sets the maximum speed possible (from 7 rpm to 20 rpm)



VAS 741 077



The tyre changer for high volume tyre shops

- powerMONT™ the innovative, fast and easy to use leverless mount/demount system
- quickLOK™ automatic center post clamping system
- smartSpeed™ the exclusive self-adjustable speed system up to 20 rpm that provides the optimum torque/speed combination to the chuck
- Optimum bead breaker system: the high-performance solutions for any tyre types:
 - Dynamic bead breaker with two disks, the solution of choice for RFT and UHP tyres. Precise, ergonomic and effortless
 - On floor bead breaker, the fastest solution for tyres with high aspect ratio
- PBD330, Pneumatic Bead Depressor for convenient demounting of hard sidewall tyres
- Ergonomic wheel lift integrated
- High rigidity for safe handling of high performance tyres
- Pedal-controlled inflator
- Mirror to control operation on the lower bead

VAS 741 077

Clamping range	inch	12 – 30
Max. rim width	inch	13
Max. tyre width	inch	15
Max. wheel diameter	mm	1200
Max. wheel weight	kg	70
Max. bead breaking width	mm	-
Dimensions (W x D x H)	mm	1481 x 1863 x 1880
Weight	kg	465
Compressed air supply	bar	8 – 12
Power supply		230 V 1ph 50/60 Hz
Chuck speed	rpm	7 – 20

VAS 741 079



The tyre changer for low-profile, UHP and run-flat tyres

- powerMONT™ the innovative, fast and easy to use leverless mount/demount system
- smartSpeed™ the exclusive self-adjustable speed system with before up to 20 rpm that provides the optimum torque/speed combination to the chuck
- Dynamic bead breaker with two disks, the solution of choice for RFT and UHP tyres. Precise, ergonomic and effortless
- Manual center post clamping system
- PBD330, Pneumatic Bead Depressor for convenient demounting of hard sidewall tyres
- High rigidity for safe handling of high performance tyres
- Pedal-controlled inflator
- Mirror to control operation on the lower bead

VAS 741 079	inch	12 – 30
Clamping range	inch	13
Max. rim width	inch	15
Max. tyre width	mm	1200
Max. wheel diameter	kg	70
Max. wheel weight	mm	-
Max. bead breaking width	mm	1481 x 1863 x 1880
Dimensions (W x D x H)	kg	420
Weight	bar	8 – 12
Compressed air supply		230 V 1ph 50/60 Hz
Power supply	rpm	7 – 20
Chuck speed		

VAS 6346 C

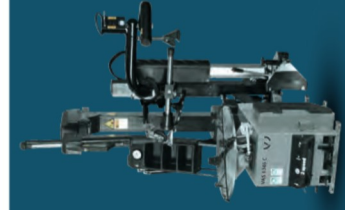

Pneumatic tilt-back post tyre changer with outer clamping range of 26"

- Outer clamping range of up to 26", with optional jaws of up to 30"
- Mounting head pneumatically adjustable in spaced-apart position relative to the rim
- smartSpeed™ technology
- Double-acting bead breaker cylinder
- Bead breaker blade supported in 3 joints, bead breaker adjustable in 2 ranges
- Pneumatic tool lock and pneumatic tool approach
- Pneumatic tilt back post, pneumatically locked in working position
- Self-centring four-jaw turntable with sliding jaws
- Pedal-operated inflator with quick-inflating valve
- Tool box with integrated precision pressure gauge

VAS 6346 C	inch	14 – 26
Inner clamping range	inch	12 – 26
Outer clamping range	inch	16
Max. rim width	inch	17
Max. tyre width	mm	1200
Max. wheel diameter	kg	70
Max. wheel weight	mm	410
Max. bead breaking width	mm	1720 x 1920 x 2260
Dimensions (W x D x H)	kg	440
Weight	bar	8 – 12
Compressed air supply		230 V 1ph 50/60 Hz
Power supply	rpm	7 / 7 – 14
Chuck speed		

VAS 741 043



Tyre changer for wheel width up to 15"

- Mounting and demounting of very wide wheels, up to 15"
- The low cabinet offers an ergonomic working height even with very wide wheels
- Vertical positioning of the mounting head is carried out pneumatically – all settings are controlled through a single switch – quickly and ergonomically
- smartSpeed™ technology
- On-side bead breaker with adjustable blade inclination, adjustable in three positions
- Double-acting bead breaker cylinder
- Mounting head adjustable
- Mounting / demounting tool (working range 8" - 24")
- Turntable with centre-type sliding jaws.
- Pedal-operated pneumatic tilt-back post
- Post pneumatically locked in working position
- Tool box with integrated pressure gauge and four ergonomic shelves
- Pedal-operated inflator with quick-inflating valve

VAS 741 043	inch	12 – 24
Inner clamping range	inch	10 – 24
Outer clamping range	inch	14
Max. rim width	inch	15
Max. tyre width	mm	1000
Max. wheel diameter	kg	70
Max. wheel weight	mm	392
Max. bead breaking width	mm	1350x1800x1920
Dimensions (W x D x H)	kg	310
Weight	bar	8 – 12
Compressed air supply		230 V 1ph 50/60 Hz
Power supply	rpm	7 / 7 – 18
Chuck speed		

VAS 741 041



Pneumatic tilt-back post tyre changer







- smartSpeed™ technology
- Double-acting bead breaker cylinder
- Mounting head adjustable in spaced-apart position relative to the rim
- Mounting / demounting tool (working range 8" – 24")
- Turntable with centre-type sliding jaws. Two clamping cylinders provide 30 to 40 % more clamping force than single-cylinder machines
- Pedal-operated pneumatic tilt-back post
- Post pneumatically locked in working position
- On-side bead breaker with adjustable blade inclination for different wheel diameters, adjustable in three positions to grant high performance and flexibility
- Tool box with integrated pressure gauge and four ergonomic shelves for valves, tools and accessories, attached on separate tower
- Pedal-operated inflator with quick-inflating valve

VAS 741 041	inch	12 – 24
Inner clamping range	inch	10 – 24
Outer clamping range	inch	12
Max. rim width	inch	13
Max. tyre width	mm	1000
Max. wheel diameter	kg	70
Max. wheel weight	mm	392
Max. bead breaking width	mm	1220x1700x1870
Dimensions (W x D x H)	kg	300
Weight	bar	8 – 12
Compressed air supply		230 V 1ph 50/60 Hz
Power supply	rpm	7 / 7 – 18
Chuck speed		

Accessories

A choice of accessories for the VAS machines

Car wheels	Light truck wheels
<p>4029029</p>  <p>Stud-hole flange FP VAG For Volkswagen, Audi, Seat and Skoda Pitch circle diameters: 5 x 100/112/120/130mm; 5 x bolts 80mm</p>	<p>24936</p>  <p>Centring cone Ø 113-170mm For steel and alloy rims with centre bore of Ø 114-169mm, on the condition the centre bore outer side is machined sufficiently accurate. To be applied only from the outside and in conjunction with spacer ring 24937.</p>
<p>4028856</p>  <p>Centring & clamping kit – Porsche STANDARD Consisting of tapered centring ring C Ø = 71,5-74,2mm, clamping ring</p>	<p>25790</p>  <p>Centring cone Ø 195-214mm For light-truck rims, steel rims with centre bore of Ø 196-213mm. For wheels of less than 65 kg and for maximum overall diameter of 900mm. To be applied only from the outside and in conjunction with spacer ring 24937.</p>
<p>4030969</p>  <p>Centring & clamping kit – Porsche GT2/GT3/Turbo Consisting of clamping ring, Porsche centring ring Ø = 84mm For Porsche rims with central nut on Porsche GT2/ GT3/Turbo</p>	<p>24937</p>  <p>Spacer ring (plastic) For light-truck rims which are clamped using special centring cones ref. no. 24936 and 25790, or using a stud-hole flange.</p>
<p>30344</p>  <p>Centring ring Ø1 = 57mm, Ø2 = 71.6mm For VW, Audi, Porsche</p>	<p>35382</p>  <p>Centring set VW Crafter Pitch circle diameter 6 x 130mm</p>
<p>26445</p>  <p>Tapered centring ring A Ø = 56.5-58.6mm</p>	<p>35383</p>  <p>Centring set VW Crafter Pitch circle diameter 6 x 205mm</p>
<p>26447</p>  <p>Tapered centring ring C Ø = 71.5-74.2mm For Audi Q7 und Porsche</p>	<p>4026401</p>  <p>Light-truck kit To handle light-truck wheels; consisting of spacer ring and cone 1.22-1.72mm</p>
<p>26449</p>  <p>Tapered centring ring E Ø = 65.9-67.7mm</p>	
<p>26451</p>  <p>Tapered centring ring G Ø = 54.5-56.2mm</p>	
<p>26452</p>  <p>Tapered centring ring H Ø = 52-54.2mm</p>	
<p>30348</p>  <p>Tapered centring ring I Ø = 66.5mm For Audi A5 2010+; all models except Q7</p>	
<p>201260</p>  <p>2" spacer ring to add another 2" between rim contact surface and machine cabinet, for wide car rims having a high offset</p>	

Car tyres	VAS 6616 VAS 741 031
	4031245
	4031040
	EAA 0364C48A
	EAA 0363G30A
	EAA 0363G40A
	4029455
	4030319

Light truck tyres	VAS 6346 C VAS 741 043 VAS 741 041
	4027629
	EAK 0279G87A
	EAK 0279G86A
	EAK 0279G89A
	4030486
	EAK 0317G76A
	EAK 0317G77A
	EAK 0317G78A

Snap-on Total Shop Solutions

FRANCE
+33 134 48 58 78

ITALY
+39 0522 733 411

UNITED STATES
800.362.4618

LATIN AMERICA
+1 501 505 2794

GERMANY
+49 8634 622 0

UNITED KINGDOM
+44 118 929 6811

CANADA
800.362.4608

Volkswagen Aktiengesellschaft
K-GVO-LW
Group After Sales – Group Service,
Literature and Systems
Workshop Equipment
Letter Box 011/4915
38442 Wolfsburg

For internal use only
Technical amendments possible
Stand MM/JJJJ