



INVEST IN THE FUTURE



French manufacturer
since 1964

Car Body Welding Systems

Catalogue Carrosserie

Catalogo Carrozzeria

Karosserie-Schweißtechnik Katalog

Catálogo de Soldadura para Carrocería

2
0
2
3



SPOT WELDING
DENT PULLER
MIG
PLASMA
INDUCTION
LIFT
RIVETING
BODYSHOP TOOLS



900 people

125 000 000

55 000 m²
2 factories

Created in 1964, GYS is a French industrial group with 900 employees around the world. Built around continuous investment in Research & Development and in the acquisition of knowledge, the company is now a major player in the design and manufacture of welding machines, battery chargers and car body repair equipment.

“ The market realities are constantly changing and the size of our family business requires us to quickly adapt to new contexts and new challenges.

We are convinced that our future is closely linked to the future of our partners. This is why we do everything in our power to understand what distributors and users expect from us and what challenges they face every day. To support them in facing these challenges, we wish to become and remain their privileged partner on the path we will travel together. ”

Bruno Bouygues,
C.E.O.



Nicolas & Bruno Bouygues

A worldwide coverage

132 countries



visit with
Youtube

INVEST IN THE FUTURE

FR
Créé en 1964, GYS est un groupe industriel français regroupant plus de 900 collaborateurs dans le monde. Fort d'un centre de recherche de premier plan, GYS est un acteur majeur dans la conception et la fabrication d'équipements de soudage, de chargeurs de batteries et de systèmes de réparation carrosserie.

Les nouvelles réalités du marché sont en perpétuel changement et la taille de notre entreprise familiale nous impose une adaptation rapide aux nouveaux contextes et à leurs enjeux.

Nous sommes convaincus que notre avenir est étroitement lié à celui de nos clients. Pour cela, nous mettons tout en oeuvre pour comprendre ce que les distributeurs et les utilisateurs attendent de nous, savoir à quels défis ils font face et voir dans quelle mesure nous pouvons leur permettre de les relever afin de devenir et rester leur partenaire privilégié pour le chemin que nous avons à parcourir ensemble.

DE
GYS wurde 1964 gegründet und ist ein französisches Familienunternehmen mit mehr als 900 Mitarbeitern auf der ganzen Welt. Dank einem erstklassigen Forschungszentrum ist GYS ein wichtiger Akteur in der Entwicklung und Herstellung von Schweißgeräten, Batterieladegeräten und Karosseriereparatursystemen.

Neue Marktbedingungen sind in fortwährender Veränderung und die Größe unseres Familienunternehmens veranlasst eine rasche Anpassung an neue Umstände und an ihre Herausforderungen.

Wir sind überzeugt, dass unsere Zukunft eng mit der unserer Kunden verbunden ist. Dafür setzen wir all unser Können ein, um zu verstehen, was die Händler und Anwender von uns erwarten, welchen Herausforderungen sie gegenüberstehen und um zu schauen, in welchem Maße wir sie unterstützen können, damit wir ihr bevorzugter Partner werden und bleiben auf dem Weg, den wir gemeinsam beschreiten.

IT
Nato nel 1964, GYS è un gruppo industriale francese che raggruppa oltre 900 collaboratori nel mondo. Forte di un centro di ricerca di grande importanza, GYS è uno dei maggiori protagonisti nella progettazione e fabbricazione di apparecchiature per la saldatura e il taglio, di cariche batterie booster e avviatori e sistemi di riparazione delle carrozzerie.

Le realtà del mercato sono in continuo cambiamento e richiedono risposte immediate. Le dimensioni della nostra impresa familiare consentono un adattamento rapido ai nuovi contesti e alle loro problematiche.

Siamo convinti che il nostro futuro sia strettamente legato a quello dei nostri clienti. Per questo noi mettiamo il massimo impegno per capire quello che i distributori e i loro clienti/utilizzatori si aspettano da noi, quali sfide devono affrontare e come possiamo aiutarli per farli crescere, per diventare e restare loro partner di riferimento per proseguire insieme sul cammino del successo.



GYS FRANCE Laval	GYS GERMANY Aachen	GYS U.K. Rugby	GYS CHINA Shanghai	GYS ITALIA Venezia	GYS IBERICA Madrid
1964 × 650	2006 × 75	2008 × 40	2004 × 110	2015 × 25	2022 × 6

Partners





GYS ACADEMY

Training centre dedicated to professionals

Centre de formation agréé

Trainingcenter für Profis

Centro di formazione dedicato ai professionisti

Ref. 52 53 0068153

3 catalogues

3 200+ references



Welding & Cutting



Car Body Welding Systems



Chargers, Boosters & Starters

DENT PULLING



GYSPT
p.6

Accessories,
levelling bars
p.20



Workstations
p.24



Pulling systems
p.32

Paintless repair
p.38

MOBILE LIFT



TROLLEY IW1
p.41



MULTITOOL TRUCK
p.41



SPOT LIFT
p.42

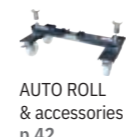

AUTO ROLL
& accessories
p.42



ERGO LIFT
& accessories
p.44

SPOT WELDING

Overview
p.47

Traditional



PORTASPOT
p.48



GYSPT 32D
p.48

Inverter



GYSPT 100R
p.49



GYSPT BP & PTI
p.50

X & C Arms
p.52

Genius



GYSPT GENIUS
p.55

G Arms
p.60

Consumables
& accessories
p.61

RIVETING



GYSPRESS
p.62

Accessories
& consumables
p.68

MIG WELDING



GYS AUTO
p.74



AUTOGYS
p.76



AUTOPULSE
p.78

Helmets, accessories
& consumables
p.84

INDUCTION



GYSDUCTION
COMBIDUCTION
p.90



POWERDUCTION
p.92

PLASMA



CUTTER & EASYCUT
p.96

+ MORE

Windscreen repair p.98

Bumper repair p.100

Tools p.102

Dust vacuum p.107 **NEW**

Working lights p.108

Working supports p.110

Safety protections p.112

Advanced R&D

90



Metal work
Tôlerie
Blechbearbeitung



Painting & marking
Peinture & marquage
Lackierstraße



Electronics
Électronique
Elektronik



Mechanical
Mécanique
CNC-Bearbeitung



Transformers
Transformateurs
Transformatoren



Cable work
Filerie
Kabelkonfektionierung

Assembly
Montage/tests
Montage

100%
in house
production

www.gys.fr





GYSPOT

DENT PULLING

ACIER / STEEL / STAHL

- Étoiles - Stars - Ausbeulstern
- Anneaux - Rings - Zugösen
- Fils ondulés - Wavy wires - Wellendraht
- Rabattage d'impact - Impact shrinking - Glätten

OPTIONS

Consommables - Consumables p.10

Chariots - Trolleys p.23



NEW DESIGN
COMING SOON

- Étoiles - Stars - Ausbeulstern
- Anneaux - Rings - Zugösen
- Fils ondulés - Wavy wires - Wellendraht
- Rabattage d'impact - Impact shrinking - Glätten
- Rétreinte - Tempering - Temperieren



FIXED GUN

FIXED GUN

GYSPOT 2600

2600 A x1 AUTOMATIC

230V • 1~

052208

included



Automatic quick gun, 1.8 m, 70 mm²
+ Hammer (057272)

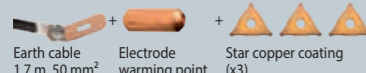

Earth cable 1.7 m, 50 mm² Electrode warming point Star copper coating (x3)

GYSPOT 2700

2600 A x1 MANUAL

230V • 1~

055353

included



Manual quick gun, 1.8 m, 70 mm² (058705)
+ Hammer (057272)

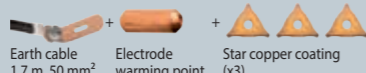

Earth cable 1.7 m, 50 mm² Electrode warming point Star copper coating (x3)

GYSPOT 34.02 & 34.04

3500 A x1 MANUAL

230V • 1~

GYSPOT 34.02
065741

400V • 2~

GYSPOT 34.04
067943

included



Manual quick gun, 2 m, 50 mm²
+ Hammer (057272)

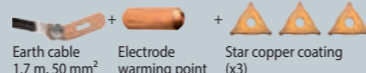

Earth cable 1.7 m, 50 mm² Electrode warming point Star copper coating (x3)

QUICK GUNS

Quick & Easy

AUTOMATIC



WITH CONNECTOR
2 m, Ø 70 mm²
included 39.02/04
057517



WITH CONNECTOR
3 m, Ø 50 mm²
included PRO 230/400
057500

WITH CONNECTOR
3 m, Ø 70 mm²
included EXPERT 200/230/400
059207

MANUAL



WITH CONNECTOR
cable 2 m, Ø 70 mm²
included PRO 230/400,
EXPERT 200/230/400,
COMBI 230EPRO
057524

No connector
cable 1.8 m, Ø 70 mm²
for 2700
058705

No connector
cable 2 m, Ø 50 mm²
for 34.02/34.04

PATENTS REGISTERED NUMBERS
001830845-0001
EUROPEAN TRADEMARK & DESIGN



7

GYSPOT

STEEL DENT PULLING

- Étoiles - Stars - Ausbeulstern
- Anneaux - Rings - Zugösen
- Fils ondulés - Wavy wires - Wellendraht
- Rabattage d'impact - Impact shrinking - Glätten
- Rétreinte - Tempering - Temperieren
- Rivets - Rivets - Nieten
- Rondelles - Rings - Unterlegscheiben
- Goujons - Studs - Gewindebolzen

SYNERGIC CONTROL

PATENTS REGISTERED NUMBERS
EUROPEAN TRADEMARK & DESIGN



GUN WITH CONNECTOR

GYSPOT 39.02 & 39.04

3800 A x1 AUTOMATIC

230V • 1~

GYSPOT 39.02
052215

400V • 2~

GYSPOT 39.04
052222

included



Automatic quick gun, 2 m, 70 mm² (057517)
+ Hammer (057272)



Earth cable 2 m, 70 mm² SPOTTER BOX STANDARD (053915)
(Details p.10)

GYSPOT PRO 230 & PRO 400

3800 A x2 AUTOMATIC
MANUAL

230V • 1~

GYSPOT PRO 230
052178

400V • 2~

GYSPOT PRO 400
052185

included



Automatic quick gun, 3 m, 50 mm² (057500)
+ Hammer (057272)

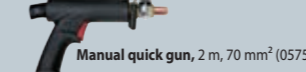

Manual quick gun, 2 m, 70 mm² (057524)



Earth cable 2 m, 70 mm² SPOTTER BOX PRO (050075)
(Details p.10)

GYSPOT EXPERT 200, 230 & 400

3800-4500 A x2 AUTOMATIC
MANUAL

230V • 1~

GYSPOT EXPERT 230
066885

200-240V • 1~

GYSPOT EXPERT 200
058842

4350 > 5100 A

400V • 2~

GYSPOT EXPERT 400
058859

included



Automatic quick gun, 3 m, 70 mm² (059207)
+ Hammer (057272)

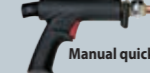

Manual quick gun, 2 m, 70 mm² (057524)

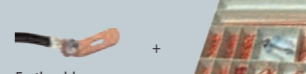

Earth cable Thick 3 mm²
2 m, 70 mm² SPOTTER BOX PRO (050075)
(Details p.10)

MADE IN GYS CHINA	G NORM 62135	50/60 Hz	I ₂ max A	U ₂ V	I _{AM} A	I _{RMS} A	kW	OK	OK	MANUAL	SYNERGIC	AUTOMATIC	MANUAL	SEPARATE CABLE GUN	cm	kg
MADE IN GYS CHINA	GYSPOT 2600	230V	2 m	2600	5,4	16	1800	10	OK	—	—	—	—	—	20 x 32 x 18	15
	GYSPOT 2700	230V	2 m	2600	5,4	16	1800	10	OK	—	—	—	—	—	20 x 32 x 18	14,5
	GYSPOT 34.02	230V	2 m	3500	7,4	16	2500	20	OK	OK	—	—	—	—	22,5 x 36 x 23,5	21
	GYSPOT 34.04	400V, 2ph	4 m	3500	7,4	16	2500	20	OK	OK	—	—	—	—	22,5 x 36 x 23,5	21
MADE IN FRANCE	GYSPOT 39.02	230V	4 m	3800	7,4	16	2800	20	OK	OK	—	—	—	—	22,5 x 36 x 23,5	22
	GYSPOT 39.04	400V, 2ph	4 m	3800	7,4	16	2800	20	OK	OK	—	—	—	—	22,5 x 36 x 23,5	22
	GYSPOT PRO 230	230V	8 m	3800	7,4	16	2800	20	OK	OK	—	—	—	—	22,5 x 36 x 23,5	20,5
	GYSPOT PRO 400	400V, 2ph	8 m	3800	7,4	16	2800	20	OK	OK	—	—	—	—	22,5 x 36 x 23,5	20,5
	GYSPOT EXPERT 200	200-240V	8 m	4350 > 5100	7,2-8,7	30(D)	3100 > 3600	25 > 36	OK	OK	—	—	—	—	22,5 x 36 x 23,5	24,5
	GYSPOT EXPERT 230	230V	8 m	3800	7,4	16	2800	20	OK	OK	—	—	—	—	22,5 x 36 x 23,5	20,5
	GYSPOT EXPERT 400	400V, 2ph	8 m	4500	7,4	16(D)	3200	25	OK	OK	—	—	—	—	22,5 x 36 x 23,5	22,5



GYSPOT ALU

DENT PULLING

ALU

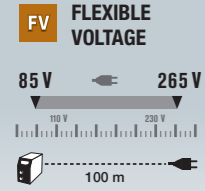

SYNERGIC CONTROL PATENTS REGISTERED NUMBERS EUROPEAN TRADEMARK & DESIGN

Alu

Goujons - Studs

Acier / Steel / Stahl

- Étoiles - Stars
- Anneaux - Rings
- Fils ondulés - Wavy wires
- Rabattage d'impact - Impact shrinking
- Rétreinte - Tempering
- Rivets - Rivets
- Rondelles - Rings
- Goujons - Studs

FIXED GUN

GYSPOT ALU PRO FV

100 · 230V · 1~
7500 A x1 AUTOMATIC

FV

021990

included for Ø 4 mm



Automatic alu gun
3 m, 25 mm²

ALU BOX STANDARD (050020)
(Details p.11)

ALU GUN

AUTOMATIC

3 m, Ø 25 mm²
included ALU PRO FV
& COMBI 230
E.PRO



(x 3)
065635

66 mF CAPACITOR DISCHARGE WELDING

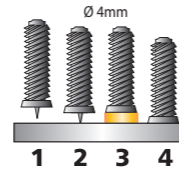

Joint rings for mandrel Ø 4/5/6
x 2
060814

OPTIONS

Consommables - Consumables p.10



Accessoires ALU - ALU accessories p.19



Chariots - Trolleys p.23



PATENTS REGISTERED NUMBERS 002446450-0001 EUROPEAN TRADEMARK & DESIGN



GYSPOT COMBI

DENT PULLING

ALU + ACIER / STEEL / STAHL

2 GUNS INCLUDED



GUN WITH CONNECTOR

GYSPOT COMBI 230 E.PRO

230V · 1~
3800 A Acier / Steel / Stahl
7500 A Alu



AUTOMATIC
MANUAL
AUTOMATIC

021266

included



Manual quick gun, 2 m, 70 mm² (057524)
+ Hammer (057272)

Automatic alu gun, 3 m, 25 mm²

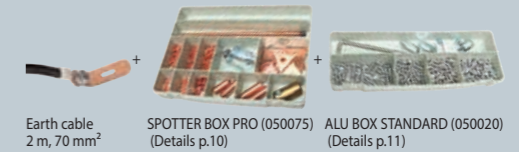

Earth cable
2 m, 70 mm²

SPOTTER BOX PRO (050075)
(Details p.10)

ALU BOX STANDARD (050020)
(Details p.11)

MADE IN FRANCE 62135	50/60 Hz			I ₂ max A	U ₂ V		I _{RMS} A	kW			MANUAL	SYNERGIC			AUTOMATIC	MANUAL	SEPARATE CABLE GUN			cm	kg
GYSPOT ALU PRO FV	110 > 230V	2 m	7500	50 > 200	5	—	0.65	OK	OK	—	—	—	—	x 1	—	—	3 m	Included Alu box	21 x 24 x 36	12.5	
GYSPOT COMBI 230 E.PRO	230V	8 m	3800 (steel) 7500 (alu)	7,4 (steel) 50 > 200 (alu)	16	2800 (steel)	20	OK	OK	—	—	—	—	x 1	x 1	—	2/3 m	Included Spotter box + Alu box	45 x 43 x 29	42.5	



DRAWN ARC

DENT PULLING

ALU + ACIER / STEEL / STAHL



FV FLEXIBLE VOLTAGE

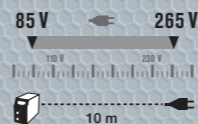

SR SECONDARY REGULATION

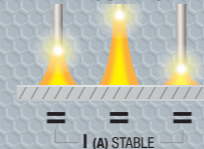

AD ANTI-DUST

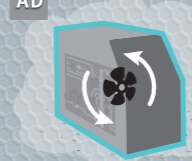

MANUAL & SYNERGIC CONTROL



MANUAL



- Anneaux - Rings - Zugösen
- Goujons - Studs - Gewindebolzen
- Tiges inox - Stainless steel nails
- Edelstahlnägel

- Amorce - Start-up - Zündung
- Décapage - Scouring (I & t) - Abbeizen
- Arc (I & t) - Arc - Lichtbogen
- Accroche - Hitching (I & t) - Verklebung
- Hauteur - Height - Höhe



7 languages
FR, EN, DE, SP, IT, NL & RU

SYNERGIC DIGITAL GUNS

UNIQUE Linear Motor

DRAWN ARC PROCESS
Gas protection

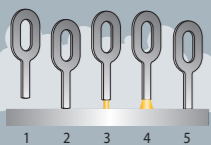

3 m, Ø 25 mm²
included
ARC PULL 200 & 350,
COMBI ARCPULL



Full control



Consumables for Gun



GYSPOT ARC PULL 200

100 · 230V · 1~
200 A x1 MANUAL
FV SR AD
057470
included

- Manual synergic gun 3 m, 25 mm²
- ALU RING BOX 1.5 mm (AlSpec + AlMg3 + AlMgSi) 059429
- x1 Lifting rod 180 mm (x3)

COMBI ARCPULL

230V · 1~	
ARCPULL	EXPERT
200 A	3800 A
Alu	Acier / Steel / Stahl
x1	x1
MANUAL	MANUAL

069824

Arccpull accessories included

- Manual synergic gun 3 m, 25 mm²
- ALU RING BOX 1.5 mm (AlSpec + AlMg3 + AlMgSi) 059429
- x1 Lifting rod 180 mm (x3)

Expert accessories included

- Manual quick gun, 2 m, 70 mm² (057524) + Hammer (057272)
- Earth cable, 2 m, 70 mm²
- SPOTTER BOX PRO (050075) (Details p.10)

GUN WITH CONNECTOR

MADE IN FRANCE 60974-1	50/60 Hz	I ₂ A	SYNERGIC			MANUAL			I ₂ A	kW	cm	Product	Product + gun			
			SYNERGIC	MANUAL	IRMS (A)	Acier/Steel	Alu	V								
GYSPOT ARC PULL 200	110 · 230V	6 m	10 · 100 (110 V)	■	■	—	Manual + Digital Gun Motion Control		20.4 · 24 V (110 V)	16	2.4 (110 V)	OK	OK	20.5 x 25 x 33	8.6 kg	11.9 kg
			10 · 200 (230 V)	■	■		Alu 20.4 · 28 V (230 V)	5.6 (230 V)	OK	OK	20.5 x 25 x 33	8.6 kg	11.9 kg			
COMBI ARCPULL	230V	8 m	Alu 10 · 200	■	■	Steel 3800	Manual (not included)	Manual	Alu 20.4 · 28 V	16	Alu 5.6	OK	OK	45 x 37 x 24.5	29 kg	39 kg
			Acier 3800	■	■	Steel 7.4 V	Steel 20	OK	OK	45 x 37 x 24.5	29 kg	39 kg				



GYSPOT ARC PULL

DRAWN ARC DENT PULLING



ALU + ACIER / STEEL / STAHL



- Anneaux - Rings - Zugösen
- Goujons - Studs - Gewindebolzen
- Tiges inox - Stainless steel nails - Edelstahlnägel
- Amorce - Start-up - Zündung
- Décapage - Scouring
- Arc (I & t) - Arc - Lichtbogen
- Accroche - Hitching
- (I & t) - Verklebung
- Hauteur - Height - Höhe



7 languages
FR, EN, DE, SP, IT, NL & RU

SPECIAL TEARING RIVETS

Spécial arrachage de rivets - Spezial-Zugnieten

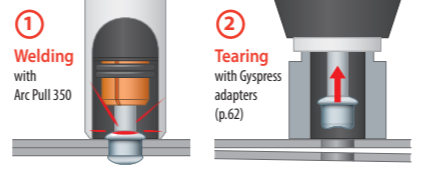

PFC POWER FACTOR CORRECTION

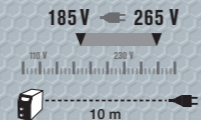

SR SECONDARY REGULATION

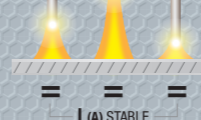

AD ANTI-DUST



∅ max
Alu/Fe: 8 mm



∅ max
Alu: 10 mm
Fe: 13 mm

NEW



3 m, ∅ 50 mm²
included
ARC PULL 700



Ideal all position

SYNERGIC DIGITAL GUNS

★★★★★ DRAWN ARC PROCESS
Gas protection

UNIQUE
Linear
Motor



FULL CONTROL

3 m, ∅ 25 mm²

included
ARC PULL
200 & 350,
COMBI ARCPULL



Consumables for Gun



GYSPOT ARC PULL 350

208 · 240V · 1~

350 A x1 MANUAL

PFC SR AD

062191

included



Manual synergic gun
3 m, 25 mm²

PACKS ARC PULL 350

	Arc Pull 350	Croco T400.70 043787	Rivet box 064584	Alu ring box 1.5 mm 059429	Rivet 059610	Lifting rods 050792
350 RIVET 064645	■	■	■	—	—	—
350 PULLER 064652	■	—	—	■	x1	180, 300, 500 mm
350 PULLER + RIVET 064669	■	■	■	■	x1	180, 300, 500 mm

GYSPOT ARC PULL 700

380 · 480V · 3~

680 A x1 MANUAL

SR IP 23

OPTIONS

details p.23



Weld 810 for ARC PULL 200 & 350 037489

Weld 910 for ARC PULL 700 070967

068315 included

- Manual synergic gun 3 m, 50 mm²
- Arc Pull Rivet Box 700
- Lifting rod 180 mm (x1)
- Ground studs holder ∅ 6 (x1) 075368, ∅ 8 (x1) 075375, ∅ 10 (x1) 075382
- Threaded holder ∅ 5 (x1) 076174, ∅ 6 (x1) 068391
- Double earth clamps 700 A, 3 m, 50 mm² 068605
- ALU RING BOX 1.5 mm (AlSpec + AlMg3 + AlMgSi) 059429
- Gas protection (x1) 068346

MADE IN FRANCE 60974-1	50/60 Hz	I ₂	SYNERGIC	TECHNOLOGY	U ₂	kW	cm	ArcPull	ArcPull + gun			
										Acier/Steel	Alu	Power Factor Correction
GYSPOT ARC PULL 350	208 · 240V	6 m	10 · 350	Manual + Digital Gun Motion Control	20.4 · 34V	16	11.9	OK	OK	23 x 31 x 28.4	11 kg	14.3 kg
GYSPOT ARC PULL 700	3x 400V 3x 480V	5 m	50 · 680	Manual + Digital Gun Motion Control	22 · 44V	20 A (D) 16 A (D)	47.8 kW 45.7 kW	OK	OK	32 x 32.4 x 41	17.4 kg	20.4 kg





GYS POT ARC PULL 200, 350 & COMBI ACCESSORIES & CONSUMABLES



ACIER / STEEL / STAHL

mandrel Ø2mm	nail Ø2mm x50mm	Ø2mm	mandrel Ø4mm	studs M4 x16mm	inox - stainless steel Ø4 x50mm	mandrel Ø5mm	studs M5 x18mm	x12mm	x18mm	self-threading studs M5	mandrel Ø6mm	studs M6 x20mm	studs internal M4 x20mm	mandrel Ø7.1mm	studs internal M5 x20mm	mandrel Ø8mm	studs M8 x20mm		
x1	x1	x1	x100	x100	x100	x1	x100	x100	x100	x100	x1	x100	x200	x1	x200	x1	x100		
059634	059641	064065	041561	064034	049000	059603	064607	048157	049383	049413	049420	048164	063969	063990	064041	064003	064058	063976	
STEEL STUDS BOX 200 & 350 059443	x1	x1			x1	x100		x1	x100	x100	x100								x1

ALU

mandrel Ø4mm	studs M4 AIMg3 x16mm	mandrel Ø5mm	studs M5 AIMg3 x16mm	mandrel Ø6mm	studs M6 AIMg3 x16mm	mandrel Ø7.1mm	studs internal M4 x20mm	mandrel Ø8mm	studs M8 AIMg3 x16mm										
x1	x1	x2	x100	x1	x100	x1	x200	x1	x100										
059634	059641	049000	059573	048157	059580	048164	059597	064010	064041	064027	064058	063983							
ALU STUDS BOX 200 & 350 059436	x1	x1	x1	x100	x1	x100	x1	x100	x1	x100									

straight rings	twisted rings														
Al-Special	AlMg3	AlMgSi	Al-Special	AlMg3 - x 50	AlMgSi - x 50										
n°1 1mm	n°4 1.5mm	n°8 2mm	n°2 1mm	n°5 1.5mm	n°3 1mm	n°6 1.5mm	n°1 1mm	n°4 1.5mm	n°2 1mm	n°5 1.5mm	n°3 1mm	n°6 1.5mm			
x100	x100	x100	x100	x100	x100	x100	x50	x50	x50	x50	x50	x50			
059535	059559	065703	059498	059511	059450	059474	059542	059566	059504	059528	059467	059481			
ALU RING BOX 1 mm 059412	1mm x50	1mm x50	1mm x50	1mm x20	1mm x20	1mm x20									
ALU RING BOX 1.5 mm 059429	1.5mm x50	1.5mm x50	1.5mm x50	1.5mm x20	1.5mm x20	1.5mm x20									
ALU RING BOX 2 mm 065703	2mm x100														



GYS POT ARC PULL 700 - ACCESSORIES & CONSUMABLES

ARC PULL RIVET BOX 700 068452	x100	x1	x1	x1	x1	x2	x1	x1	x1	Ø6 (x1) 075368	Ø5 (x1) 076174	50 mm², 3 m, 700 A 068605
	Ø5 x50 mm	Canon long + mandrin M5 - Long barrel + mandrel M5	Buse d'extraction 50 Kn Ø5	Support porte-goujon - Mandrel support	Buse + patin - Nozzle + pad	Ring holder	Fourche pour anneau - Rod for pulling rings	Vis de butée	Gas protection (x1) 068346	Ø8 (x1) 075375	Ø10 (x1) 075382	
	070745	070738	066151	071377	059641	059610	071384			Ø6 (x1) 075368	Ø8 (x1) 075375	



FAST DENT PULLING



ACIER / STEEL / STAHL

EASY TOOL CONNECTION

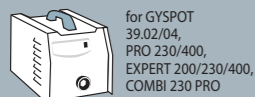

for GYSPOT
39.02/04,
PRO 230/400,
EXPERT 200/230/400,
COMBI 230 PRO

051690



3 m
Ø 35 mm²



Masse pistolet acier
- Steel gun earth adapter
- Masse für Stahl Pistole

051997



Ø 25 mm²



051584

380 g



Anneaux
- Rings
- Anschweißösen

051652



Fils ondulés
- Wavy wires
- Wellendraht

051669

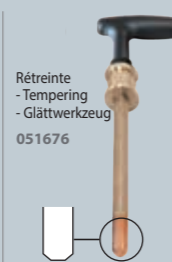

Rétreinte
- Tempering
- Glättwerkzeug

051676



EASYGUN
051317



Box of 3
electrodes for
accessories
050822



Poignée
de tirage
manuel
057289

MANUSPOT =

050679



Tools set & support
for DENT 600, 800, 1000, 1600,
Workstation & Dentstation



EASYGUN
051317

MANULINER

050471



3 m
Ø 35 mm²

PATENTS REGISTERED NUMBERS
001652108-0003
EUROPEAN TRADEMARK & DESIGN

MANULINER/GUN

056831

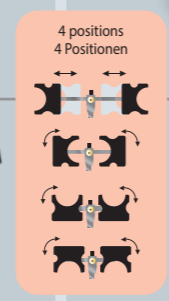

4 positions
4 Positionen

Adaptateur pistolet
- Gun adapter
included
052499



PATENTS REGISTERED NUMBERS
001652108-0003
EUROPEAN TRADEMARK & DESIGN

Direct impact electrodes (x5)
050839

Patins - Pads (x2)
060807

FAST & EASY



RINGMATIC

052154

included
(x 50)

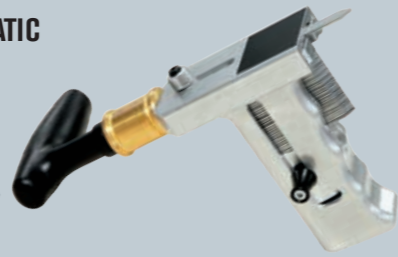

Option
Adaptateur
pistolet - Gun
adapter
052499

AFFUTEUR D'ANNEAUX ACIER - Steel Ring sharpener - Stahl Zugösenstecher

072565



Poinçon et matrice affuteur
pneumatique pour anneaux
acier - Pneumatic punch and
die sharpener for steel rings
072299

QUICK SPOT AIR GUN V2

057340

LIGHT
920 g



2,5 m

QUICK SPOT AIR GUN V2 + Mini-fraiseuse - Mini-Druckluftfräser

065567

057340 + 063228



Included
Tungsten drill
Ø 6 mm
054172

Adaptateur pistolet - Gun adapter
052826

ALU

ARC PULLER PREMIUM

065161



Included
Alu 3
065178

Included
Alu 4
065185

Patins - Pads
(x2)
069008

ULTRA RESISTANT
No deformation

GRIP
Full rotation

Multi positions

ARC PULLER PREMIUM PRO

072572



Patins - Pads
(x4)
074958

Included
Alu 3
065178

Included
Alu 4
065185

ALU PULLER

051003

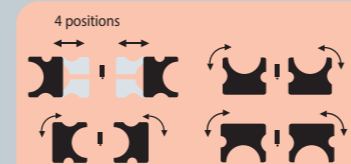

4 positions



Included
Alu 1
050938

Included
Alu 2
050945

Patins - Pads (x2)
060807

LAMPE LIGNE DROITE

- Straight line lamp - Dentline-laser

056770



ANNEAUX DE TIRAGE RAPIDE

- Fast pulling rings

058743

058712

x5

goujons alu
- alu screws
Ø 4, 5 & 6 mm

Alu 1
050938

Alu 2
050945

Marteau à
inertie 380 g
050051

MARTEAUX ALU

- Alu hammers

020986



MARTEAUX INERTIE - Slide hammers - Ausbeulhammer

COMPLETE 057272

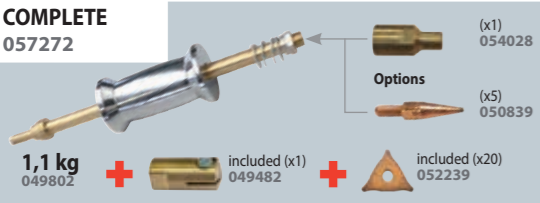

(x1) 054028
Options
(x5) 050839
(x20) 052239

1,1 kg 049802

included (x1) 049482
included (x20) 052239

Clous - Nails - Nägel



1,1 kg 041813

MIG/MAG nozzle for Nail welding 041523
Ø2 (x100) 041561
Ø 2, M4 (x1) 049277

Rondelles - Washers - Ringe

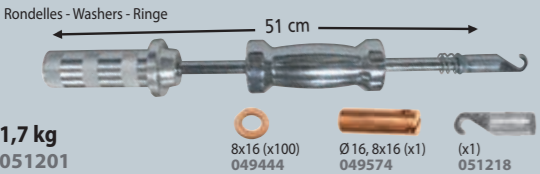

1,7 kg 051201

51 cm

8x16 (x100) 049444
Ø 16, 8x16 (x1) 049574
(x1) 051218

COMPLETE KIT 051225

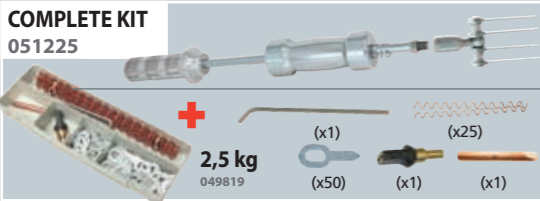

2,5 kg 049819

(x1) (x25)
(x50) (x1) (x1)

Kit marteau à inertie - Inertia hammer kit - Ausbeulhammerset



6 kg 051928

Poignée de tirage 3 dents - Pulling handle 3 claws - Handzugkralle 3-fach



057326

Poignée de tirage 2 dents - Handzugkralle 2-fach 057319

Alu Puller 051003



Mini Puller 050921

Alu 1 050938
Alu 2 050945

GRIFFES - Gripping hook head - Ausbeulhaken

Compatibility:

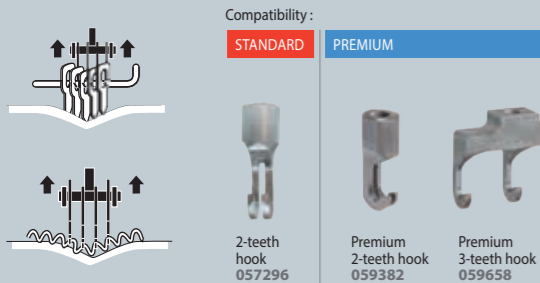
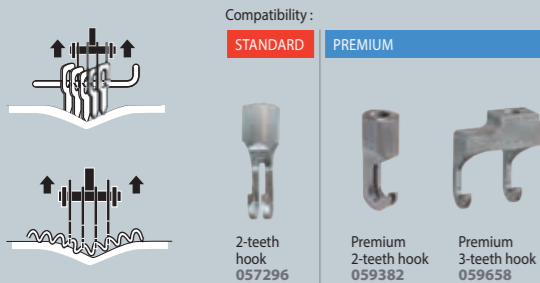
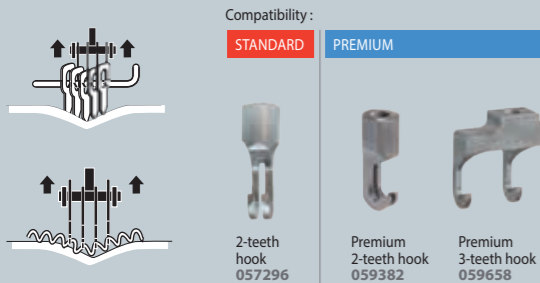
STANDARD	PREMIUM
 2-teeth hook 057296	 Premium 2-teeth hook 059382  Premium 3-teeth hook 059658

Curved lifting rod 280 mm 064706

Lifting rods 180, 300 & 500 mm 050792

STANDARD

Lever de débosselage - Levelling lever - Zughebel 1.6 kg

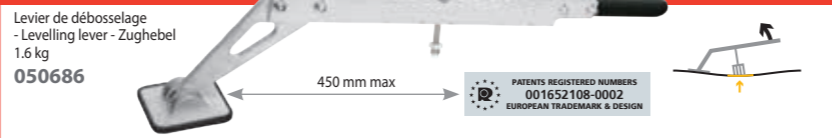

450 mm max

PATENTS REGISTERED NUMBERS 001652108-0002
EUROPEAN TRADEMARK & DESIGN

Barre de débosselage double action - Double action levelling bar - Zughebelbrücke 053564

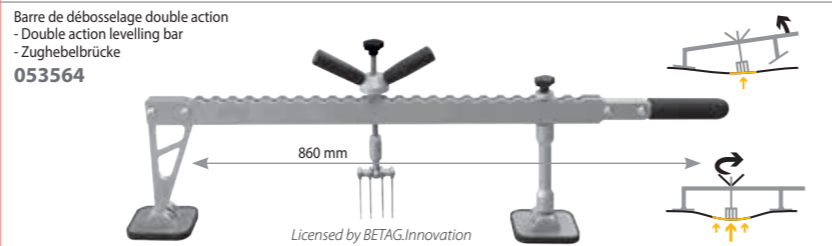

860 mm

Licensed by BETAG.Innovation

Barre de débosselage - Levelling bar - Zugbrücke 3.4 kg

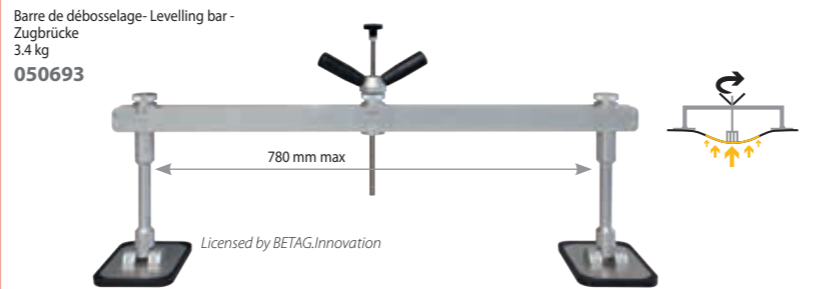

780 mm max

Licensed by BETAG.Innovation

Barre de tirage renforcée - Reinforced scissoring bar - Scherenzugbrücke 5.1 kg

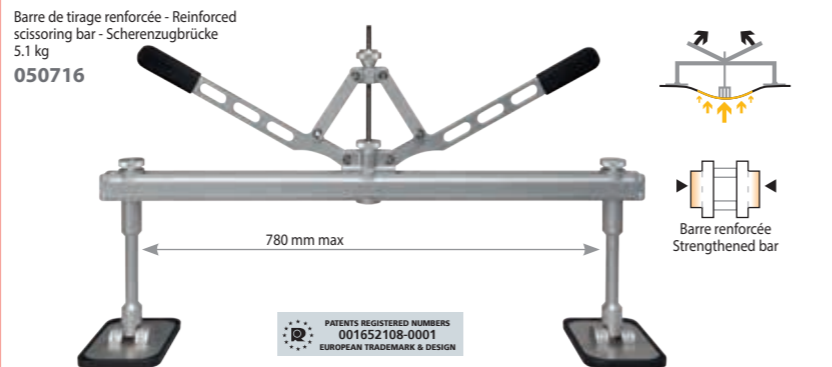

780 mm max

PATENTS REGISTERED NUMBERS 001652108-0001
EUROPEAN TRADEMARK & DESIGN

Barre renforcée Strengthened bar

OPTIONS

Barre renforcée - Reinforced bar - 1200mm 051171

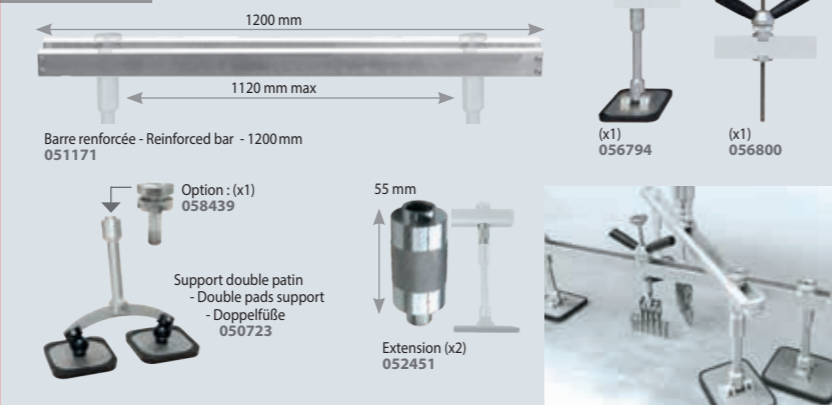

1200 mm
1120 mm max

(x1) 056794 (x1) 056800

Option : (x1) 058439

Support double patin - Double pads support - Doppelfüße 050723

55 mm

Extension (x2) 052451

PREMIUM

ULTRA LIGHT

ULTRA ERGONOMIC

ULTRA RESISTANT
No deformation

PERFECT BALANCE

Lever de débosselage Premium - Premium Levelling lever - Premium Zughebel 1.6 kg

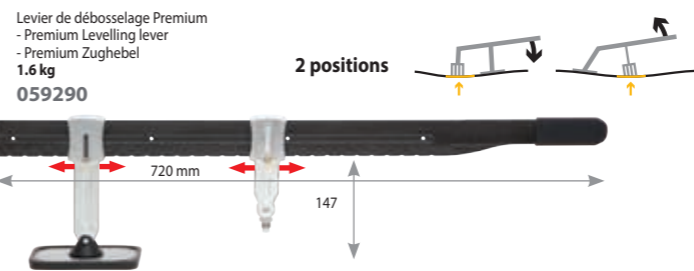

059290

2 positions

720 mm 147

Barre de débosselage Premium - Premium levelling bar - Premium Zugbrücke 2.8 kg

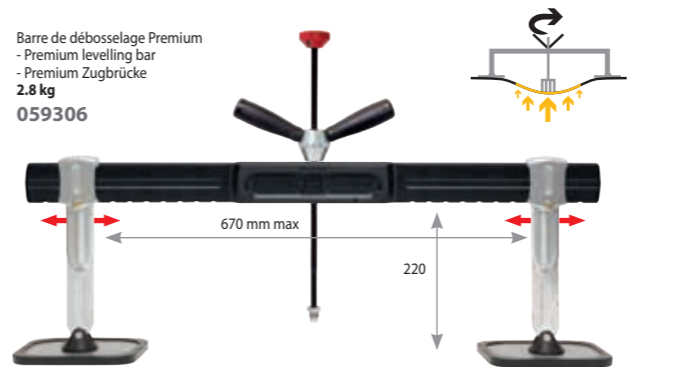

059306

670 mm max 220

Barre de tirage Premium - Premium scissoring bar - Premium Scherenzugbrücke 3.1 kg

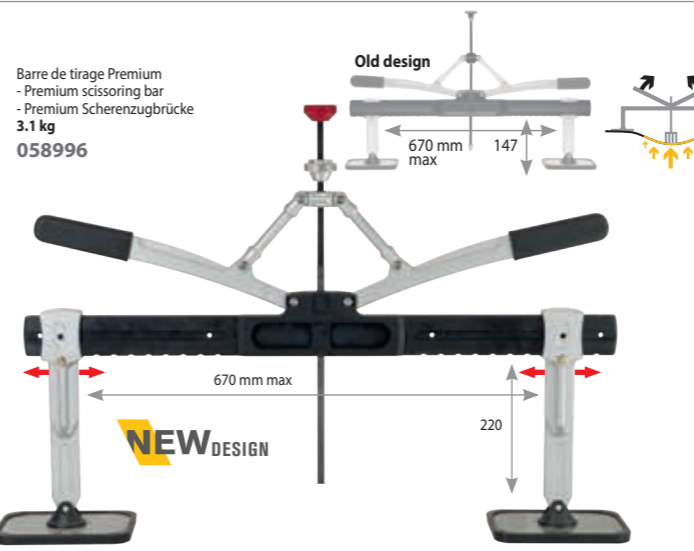

058996

Old design

670 mm max 147

NEW DESIGN

670 mm max 220

Barre de tirage 1200 renforcée Premium - Premium 1200 scissoring bar - Premium Scherenzugbrücke 1200 5.6 kg

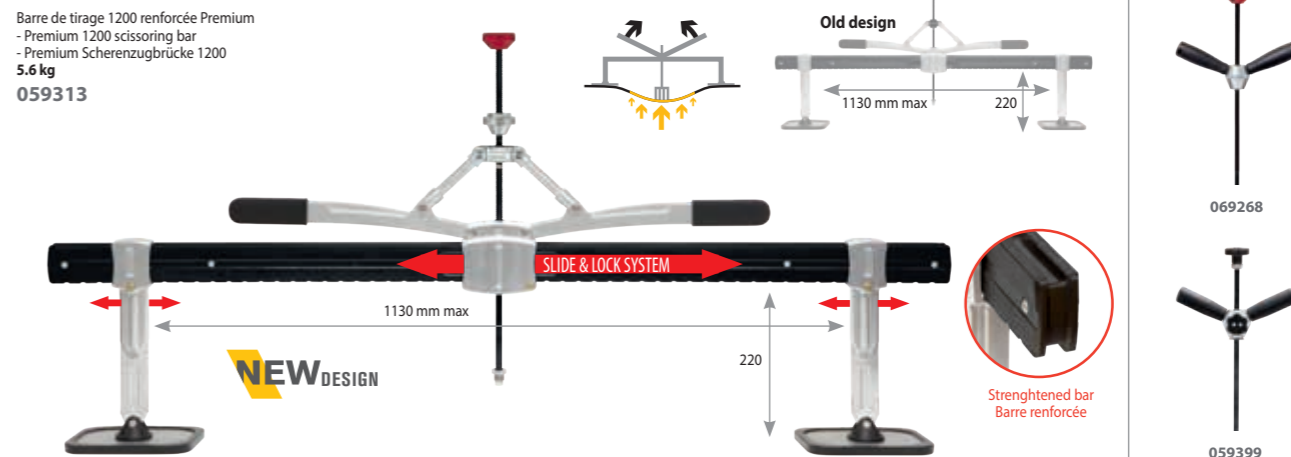

059313

Old design

1130 mm max 220

NEW DESIGN

1130 mm max 220

SLIDE & LOCK SYSTEM

Strengthened bar Barre renforcée

069268

059399

x2 059375 150

x2 059351 150

x1 072688 270

x1 059320 150

x2 061293 220

Arc Puller Premium 065161



Alu 4 065185
Alu 3 065178
Patin - Pads (x2) 069008

Multi positions



SLIDE & LOCK

GRIP

FULL ROTATION

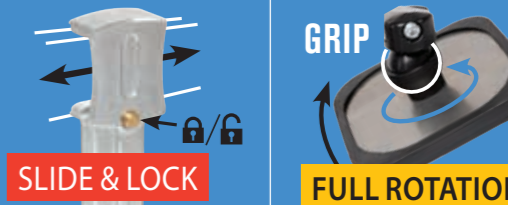

PREMIUM PRO

Barre de débousselage Premium Pro 900 mm
 - Premium Pro levelling bar 900 mm
 - Premium Pro Zugbrücke 900 mm
 3.8 kg
 071643

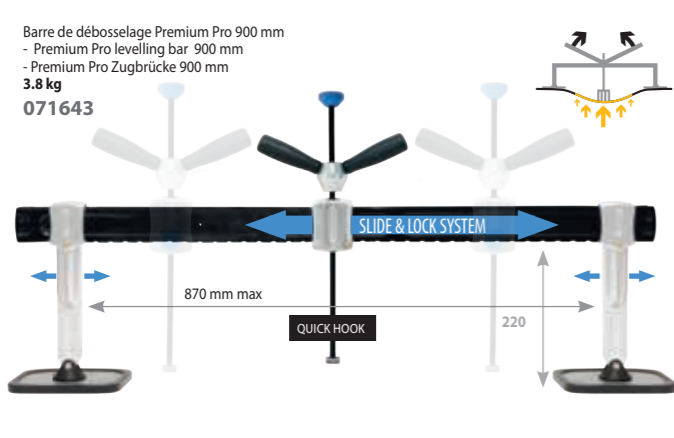

Barre de tirage Premium Pro 900 mm
 - Premium Pro scissoring bar 900 mm
 - Premium Pro Scherenzugbrücke 900 mm
 4.5 kg
 072305

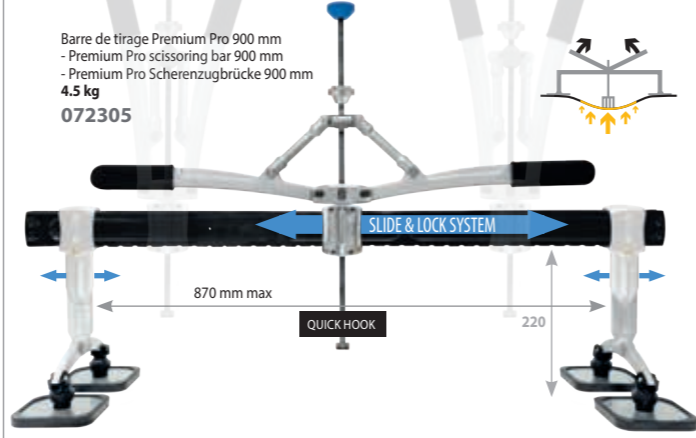

Levier de débousselage Premium Pro
 - Premium Pro Levelling lever
 - Premium Pro Zughebel
 1.6 kg
 072619

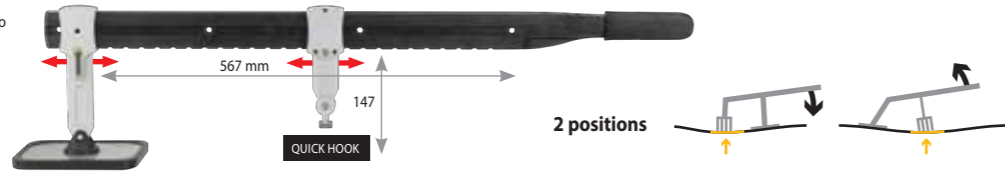

Barre Premium Pro 1150 mm
 - Premium Pro bar 1150 mm
 - Premium Pro Scherenzugbrücke 1150 mm
 072626



OPTIONS

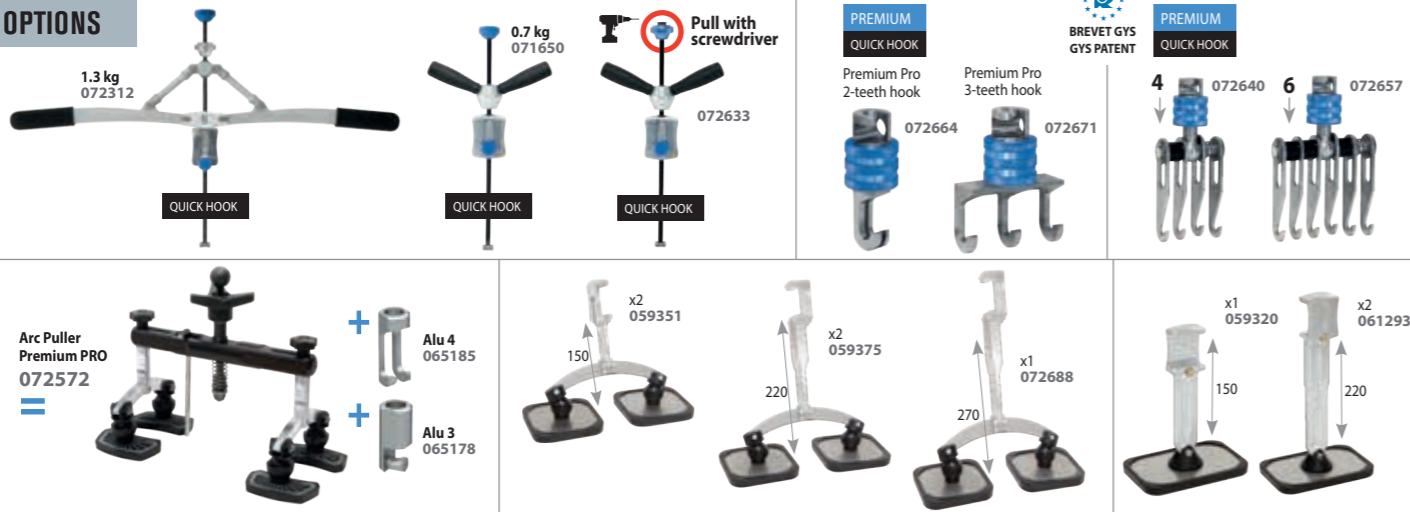

PREMIUM BAR SMARHAND

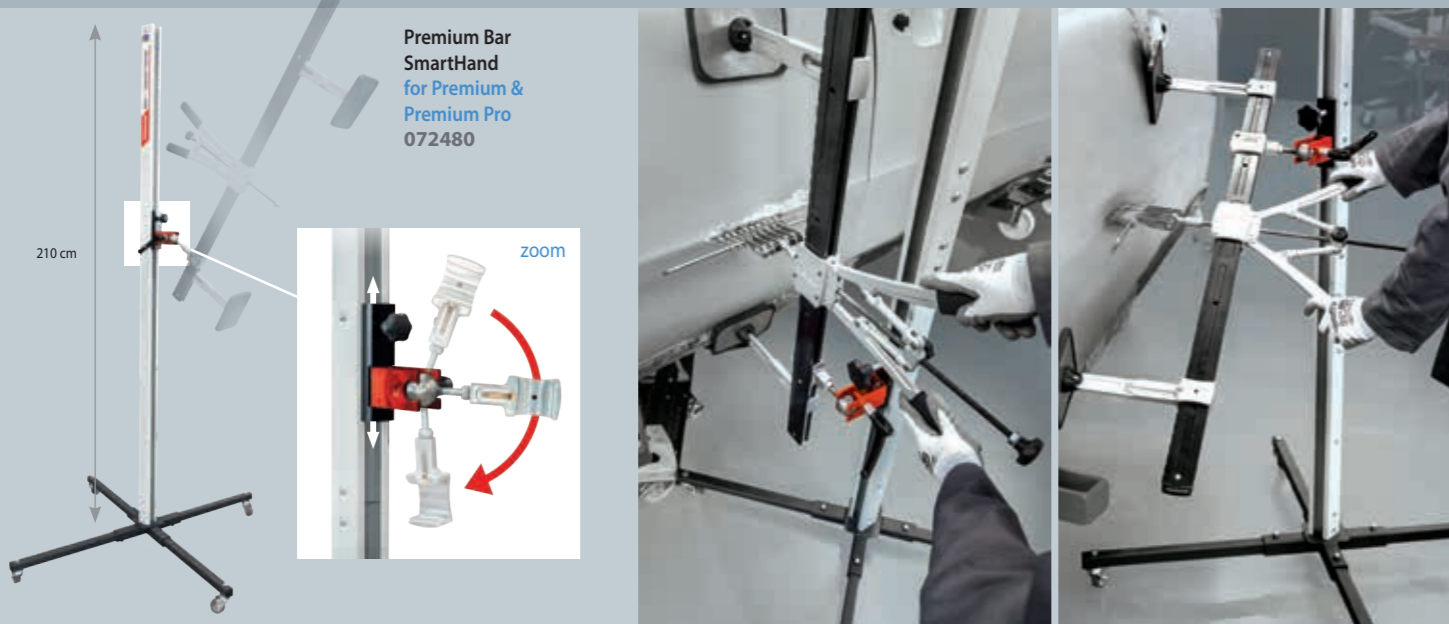

DENT PULLING WORKSTATIONS

CHARIOTS / TROLLEYS

Spot 600
 39 x 14 x 60 cm,
 7.1 kg
 053533



NEW DESIGN
 COMING SOON

Dent 600
 072831



Spot 1000
 39 x 14 x 60 cm,
 10.8 kg
 053540



NEW DESIGN
 COMING SOON

Dent 1000
 072848



Universal 800
 52 x 15 x 80 cm,
 18.1 kg
 051331

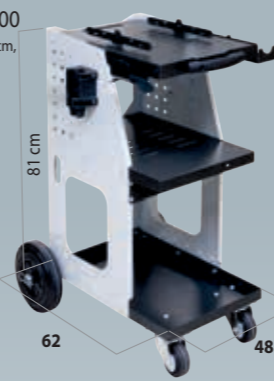

Weld 810
 55 x 22 x 78 cm,
 21.6 kg
 037489

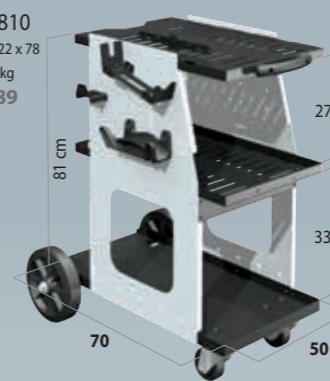

Weld 910
 79 x 50 x 115 cm,
 27.5 kg
 070967

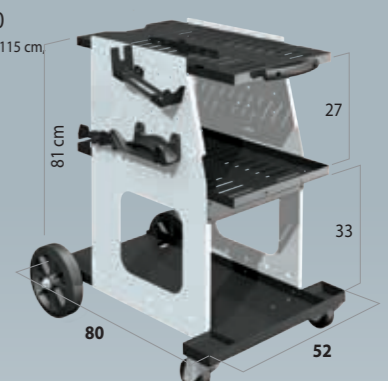

NEW

Dent 1600
 072596

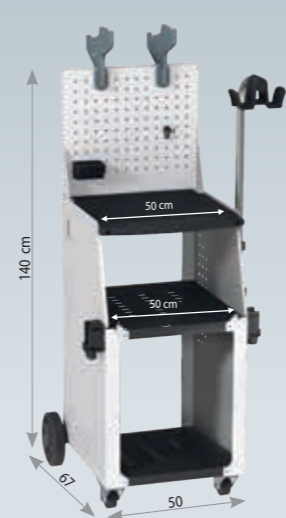

Dent 1600 WD
 072169

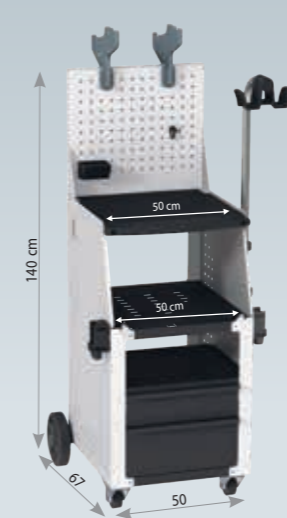

Dentstation PRO
 81 x 29 x 61 cm, 58 kg
 056848



NEW

Dentstation Pro WD
 072800

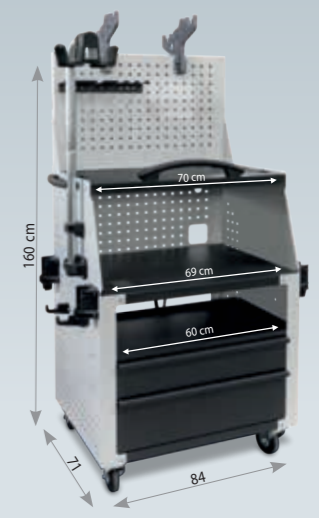

Compatibility

SPOT	Spot 600	Dent 600	Spot 1000	Dent 1000	Weld 810	Weld 910	Universal 800	Dent 1600	Dent 1600 WD	Dentstation Pro	Dentstation Pro WD
2600, 2700	*	*	*	*	*	*	*	*	*	*	*
34.02/04	*	*	*	*	*	*	*	*	*	*	*
3902/04	*	*	*	*	*	*	*	*	*	*	*
PRO 230/400	*	*	*	*	*	*	*	*	*	*	*
EXPERT 230/400	*	*	*	*	*	*	*	*	*	*	*
ALU PRO FV	*	*	*	*	*	*	*	*	*	*	*
COMBI 230 E.PRO	*	*	*	*	*	*	*	*	*	*	*
ARCPULL 200/350	*	*	*	*	*	*	*	*	*	*	*
ARCPULL 700	*	*	*	*	*	*	*	*	*	*	*



4 m³ support for Spot 1600 & Dentstation Pro 059665



Housse de protection - Protection cover - Schutzhaube for Universal 800 062733

Cable support for Spot 800, 1600 & Dentstation 052284

for Spot 1600 & Dent 1600 048881

for Dentstation Pro 059870





DENT PULLING WORKSTATIONS

UNE SOLUTION COMPLÈTE
A COMPLETE SOLUTION
KOMPLETTLÖSUNGEN



✓ PRO 230 072398

EASYLINER ACIER / STEEL / STAHL



✓ PRO 230 035799
✓ PRO 400

PROLINER ACIER / STEEL / STAHL



✓ 39.02
✓ 39.04 035782

EASYLINER ACIER / STEEL / STAHL

			ALL IN 1 BOX
GYSPOT (guns & consumables included)	DENT 1000 072848	Levelling bar double action 053564 + Dent box easy 053632	
39.02 053618 058521	GYSPOT 39.02	✓	
PRO 230 072398	GYSPOT PRO 230	✓	

PROLINER ALU

GYSPOT (guns & consumables included)	UNIVERSAL 800 051331	Cable support 052284	Alu puller 051003
ALU PRO FV 035836	GYSPOT ALU PRO FV ✓	✓	✓

PROLINER ACIER / STEEL / STAHL

GYSPOT (guns & consumables included)	UNIVERSAL 800 051331	Cable support 052284	Levelling bar double action 053564 + Dent box bar 050037
39.02 035775	GYSPOT 39.02	✓	✓
39.04 035782	GYSPOT 39.04	✓	✓
PRO 230 035799	GYSPOT PRO 230	✓	✓
PRO 400 035805	GYSPOT PRO 400	✓	✓

PROLINER ALU (ACIER / STEEL / STAHL)

GYSPOT (guns & consumables included)	Weld 810 037489	Cable support 052284	Arc puller premium 065161
ARC PULL 200 065260	GYSPOT ARC PULL 200 ✓	✓	✓



✓ ALU PRO FV 035836

PROLINER ALU



✓ ARC PULL 200 065260

ALU (ACIER / STEEL / STAHL)

SPEEDLINER V2

ALU PRO FV 074552	GYSPT ALU PRO FV												
39.02 074422	GYSPT 39.02												
39.04 074439	GYSPT 39.04												
PRO 230 074446	GYSPT PRO 230												
PRO 400 074453	GYSPT PRO 400												
EXPERT 200 074460	GYSPT EXPERT 200												
EXPERT 230 074477	GYSPT EXPERT 230												
EXPERT 400 074484	GYSPT EXPERT 400												
COMBI 230EPRO 074491	GYSPT COMBI 230 E.PRO	✓	×2										
ARC PULL 200 074507	GYSPT ARC PULL 200 + PRO 230												
+ PRO 400 074514	GYSPT ARC PULL 200 + PRO 400												
+ EXPERT 200 074521	GYSPT ARC PULL 200 + EXPERT 200	✓	×2										
+ EXPERT 230 074538	GYSPT ARC PULL 200 + EXPERT 230												
+ EXPERT 400 074545	GYSPT ARC PULL 200 + EXPERT 400												
without generator	035058												

SPEEDLINER PREMIUM V2

ARC PULL 200 073999	GYSPT ARC PULL 200														
ARC PULL 350 074934	GYSPT ARC PULL 350														
PRO 230 073883	GYSPT PRO 230														
PRO 400 073890	GYSPT PRO 400														
EXPERT 200 073906	GYSPT EXPERT 200														
EXPERT 230 073920	GYSPT EXPERT 230														
EXPERT 400 073944	GYSPT EXPERT 400														
COMBI 230EPRO 073968	GYSPT COMBI 230 E.PRO	✓	×2												
COMBI ARCPULL 074569	GYSPT COMBI ARCPULL														
ARC PULL 200 073975	GYSPT ARC PULL 200 + PRO 230														
+ PRO 400 073982	GYSPT ARC PULL 200 + PRO 400														
+ EXPERT 200 073913	GYSPT ARC PULL 200 + EXPERT 200	✓	×2												
+ EXPERT 230 073937	GYSPT ARC PULL 200 + EXPERT 230														
+ EXPERT 400 073951	GYSPT ARC PULL 200 + EXPERT 400														

✓ ALU PRO FV 074552

✓ 39.02, 39.04
✓ PRO 230, PRO 400 074477
✓ EXPERT 200, EXPERT 230, EXPERT 400

SPEEDLINER V2 ALU ACIER / STEEL / STAHL

COMPLETE SYSTEM

✓ COMBI 230 E.PRO
✓ ARC PULL 200 + PRO 230
✓ ARC PULL 200 + PRO 400
✓ ARC PULL 200 + EXPERT 200
✓ ARC PULL 200 + EXPERT 230
✓ ARC PULL 200 + EXPERT 400 074538

SPEEDLINER V2 ALU + ACIER / STEEL / STAHL

PREMIUM COMPLETE SYSTEM

✓ COMBI 230 E.PRO
✓ COMBI ARCPULL
✓ ARC PULL 200 + PRO 230
✓ ARC PULL 200 + PRO 400
✓ ARC PULL 200 + EXPERT 200
✓ ARC PULL 200 + EXPERT 230
✓ ARC PULL 200 + EXPERT 400 073937

SPEEDLINER PREMIUM V2 ALU + ACIER / STEEL / STAHL

✓ ARC PULL 200, ARC PULL 350 073999

✓ PRO 230, PRO 400 073920
✓ EXPERT 200, EXPERT 230, EXPERT 400

SPEEDLINER PREMIUM V2 ALU ACIER / STEEL / STAHL



DENTSTATION

	Dentstation Pro 056848 + Fixing kit 051362	Cable support 052284	Manuspot 050679	Ringmatic 052154	Manual pulling handle 057289	Levelling lever 050686 + Levelling bar 050693 + Scissoring bar 050716	Double pads 050723 + Strengthened bar 051171 + Extensions (x2) 052451	Multihook heads 049758 + 049734 + 049741	3 lifting rods 050792	Dent box consumables 051515	Empty box 320x113mm	Magnetic earth 049666	Fast pulling rings (x5) 058712 + Alu puller 051003	Arc puller premium 065161	4 m ³ support 059665 + Flanges (x 2) 062146
39.02 028012	GYSPT 39.02					✓									
39.04 028029	GYSPT 39.04					✓									
PRO 230 036420	GYSPT PRO 230														
PRO 400 036437	GYSPT PRO 400														
EXPERT 200 036734	GYSPT EXPERT 200					✓									
EXPERT 230 067028	GYSPT EXPERT 230														
EXPERT 400 036741	GYSPT EXPERT 400														
COMBI 230 E.PRO 036444	GYSPT COMBI 230 E.PRO	✓	x2			✓							✓		
ARC PULL 200 + PRO 230 069039	GYSPT ARC PULL 200 + PRO 230														
+ PRO 400 069077	GYSPT ARC PULL 200 + PRO 400														
+ EXPERT 200 065321	GYSPT ARC PULL 200 + EXPERT 200	✓	x2			✓									✓
+ EXPERT 230 067035	GYSPT ARC PULL 200 + EXPERT 230														
+ EXPERT 400 065338	GYSPT ARC PULL 200 + EXPERT 400														

DENTSTATION PREMIUM

	Dentstation Pro 056848 + Fixing kit 051362	Cable support 052284	Manuspot 050679	Ringmatic 052154 + Manual pulling handle 057289	Manual pulling handle 057289 + Premium levelling lever 059290 + Premium levelling bar 059306 + Premium scissoring bar 058996 + Premium levelling lever 1200 059313	Premium double pads support 150 mm 059351 + 220 mm 059375	Hook head 049734 + 059658 + 059382	3 lifting rods 050792	Dent box consumables 051515 + Empty box 320x113mm	Magnetic earth 049666	Fast pulling rings (x5) 058712 + Alu puller 051003	Arc puller premium 065161	4 m ³ support 059665 + Flanges (x 2) 062146
PRO 230 028067	GYSPT PRO 230												
PRO 400 028074	GYSPT PRO 400												
EXPERT 200 036758	GYSPT EXPERT 200												✓
EXPERT 230 067042	GYSPT EXPERT 230												
EXPERT 400 036765	GYSPT EXPERT 400												
COMBI 230 E.PRO 036772	GYSPT COMBI 230 E.PRO	✓	x2			✓						✓	
COMBI ARCPULL 074941	GYSPT COMBI ARCPULL												
ARC PULL 200 + PRO 230 069046	GYSPT ARC PULL 200 + PRO 230												
+ PRO 400 069084	GYSPT ARC PULL 200 + PRO 400												
+ EXPERT 200 065345	GYSPT ARC PULL 200 + EXPERT 200	✓	x2			✓							✓
+ EXPERT 230 067059	GYSPT ARC PULL 200 + EXPERT 230												
+ EXPERT 400 065352	GYSPT ARC PULL 200 + EXPERT 400												



✓ 39.02, 39.04
✓ PRO 230, PRO 400
✓ EXPERT 200, EXPERT 230, EXPERT 400
036741

DENTSTATION ACIER / STEEL / STAHL

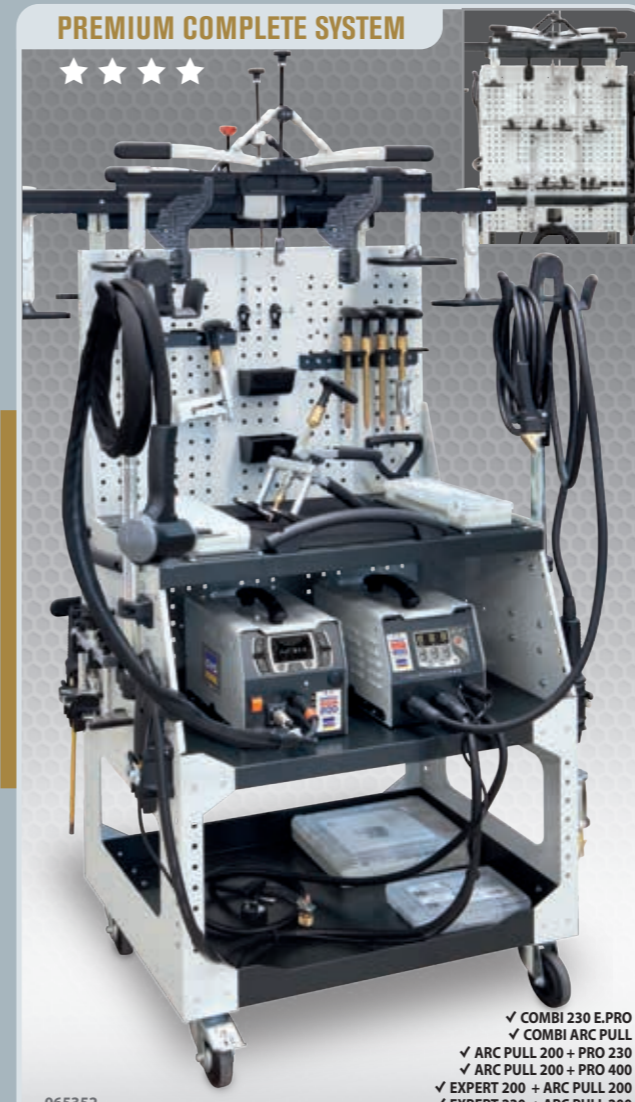

✓ COMBI 230 E.PRO
✓ COMBI ARCPULL
✓ ARC PULL 200 + PRO 230
✓ ARC PULL 200 + PRO 400
✓ EXPERT 200 + ARC PULL 200
✓ EXPERT 230 + ARC PULL 200
✓ EXPERT 400 + ARC PULL 200
065352

DENTSTATION PREMIUM ALU + ACIER / STEEL / STAHL



✓ COMBI 230 E.PRO
✓ ARC PULL 200 + PRO 230
✓ ARC PULL 200 + PRO 400
✓ EXPERT 200 + ARC PULL 200
✓ EXPERT 230 + ARC PULL 200
✓ EXPERT 400 + ARC PULL 200
065338

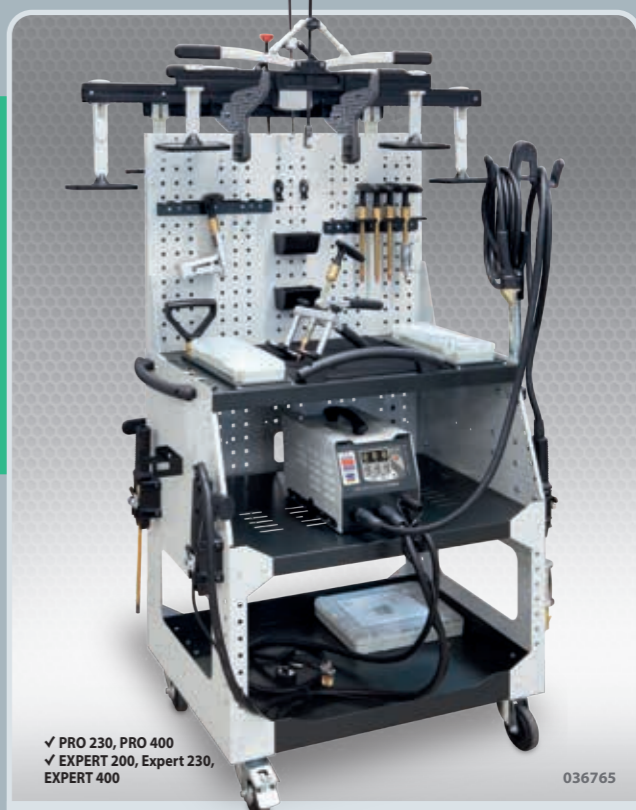

DENTSTATION ALU + ACIER / STEEL / STAHL



























✓ PRO 230, PRO 400
✓ EXPERT 200, Expert 230, EXPERT 400
036765

DENTSTATION PREMIUM ACIER / STEEL / STAHL

DENTSTATION PREMIUM PRO

 GYSPT EXPERT 230 (guns & consumables included) 066885	 Dentstation Pro WD 072800	 Manuspot 050679	 Ringmatic 052154	 Manual pulling handle 057289	 3 lifting rods 050792	 Dent box consumables 051515	 Magnetic earth 049666	 Levelling bar & scissoring bar Premium Pro 072305 - 071643 072619 - 072626	 071650 072312	 Gripping hook head 072664 - 072671 072640 - 072657	 Double padded feet 270 mm 072688
STEEL ACCESSORIES PACK 073821											
GYSPT EXPERT 230 + DENTSTATION PRO WD + STEEL ACCESSORIES PACK = 073845											

 GYSPT EXPERT 400 (guns & consumables included) 058859	 Dentstation Pro WD 072800	 Manuspot 050679	 Ringmatic 052154	 Manual pulling handle 057289	 3 lifting rods 050792	 Dent box consumables 051515	 Magnetic earth 049666	 Levelling bar & scissoring bar Premium Pro 072305 - 071643 072619 - 072626	 071650 072312	 Gripping hook head 072664 - 072671 072640 - 072657	 Double padded feet 270 mm 072688
STEEL ACCESSORIES PACK 073821											
GYSPT EXPERT 400 + DENTSTATION PRO WD + STEEL ACCESSORIES PACK = 073852											

 GYSPT COMBI ARCPULL (guns & consumables included) 069824	 Dentstation Pro WD 072800	 Manuspot 050679	 Ringmatic 052154	 Manual pulling handle 057289	 3 lifting rods 050792	 Dent box consumables 051515	 Magnetic earth 049666	 Levelling bar & scissoring bar Premium Pro 072305 - 071643 072619 - 072626	 071650 072312	 Gripping hook head 072664 - 072671 072640 - 072657	 Double padded feet 270 mm 072688	 Potence pour servantes de débosselage 052284	 4 m³ support 059665	 Arc Puller Premium Pro 072572
STEEL ACCESSORIES PACK 073821														
ALU ACCESSORIES PACK 073838														
GYSPT COMBI ARCPULL + DENTSTATION PRO WD + STEEL ACCESSORIES PACK + ALU ACCESSORIES PACK = 073869														

 GYSPT EXPERT 400 + ARCPULL 200 (guns & consumables included) 058859 + 057470	 Dentstation Pro WD 072800	 Manuspot 050679	 Ringmatic 052154	 Manual pulling handle 057289	 3 lifting rods 050792	 Dent box consumables 051515	 Magnetic earth 049666	 Levelling bar & scissoring bar Premium Pro 072305 - 071643 072619 - 072626	 071650 072312	 Gripping hook head 072664 - 072671 072640 - 072657	 Double padded feet 270 mm 072688	 Potence pour servantes de débosselage 052284	 4 m³ support 059665	 Arc Puller Premium Pro 072572
STEEL ACCESSORIES PACK 073821														
ALU ACCESSORIES PACK 073838														
GYSPT EXPERT 400 + ARCPULL 200 + DENTSTATION PRO WD + STEEL ACCESSORIES PACK + ALU ACCESSORIES PACK = 073876														

 GYSPT EXPERT 400 + ARCPULL 350 (guns & consumables included) 058859 + 062191	 Dentstation Pro WD 072800	 Manuspot 050679	 Ringmatic 052154	 Manual pulling handle 057289	 3 lifting rods 050792	 Dent box consumables 051515	 Magnetic earth 049666	 Levelling bar & scissoring bar Premium Pro 072305 - 071643 072619 - 072626	 071650 072312	 Gripping hook head 072664 - 072671 072640 - 072657	 Double padded feet 270 mm 072688	 Potence pour servantes de débosselage 052284	 4 m³ support 059665	 Arc Puller Premium Pro 072572	 Alu Ring Box 1,5 mm 059429 - 059610
STEEL ACCESSORIES PACK 073821															
ALU ACCESSORIES PACK 073838															
GYSPT EXPERT 400 + ARCPULL 350 + DENTSTATION PRO WD + STEEL ACCESSORIES PACK + ALU ACCESSORIES PACK = 076020															

STEEL ACCESSORIES

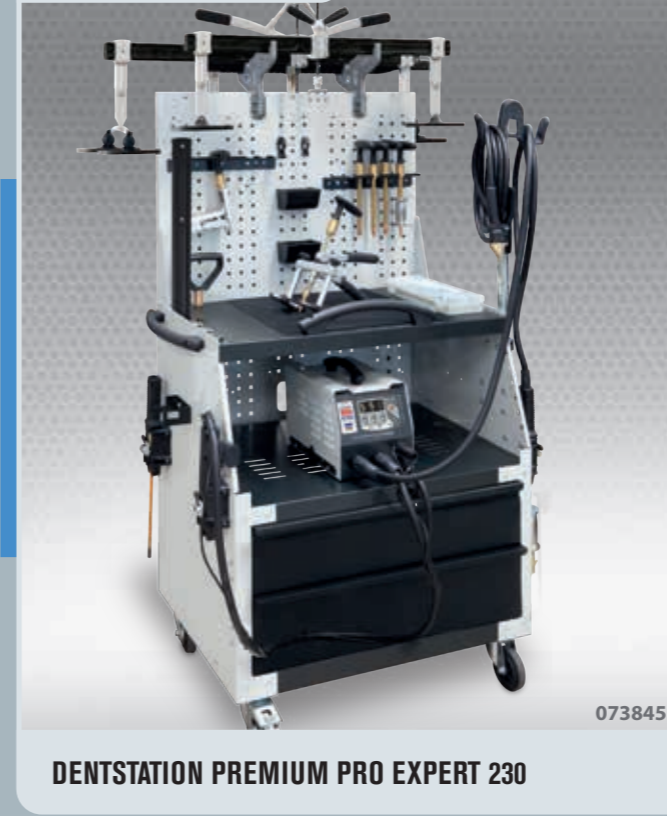

073845

DENTSTATION PREMIUM PRO EXPERT 230

STEEL ACCESSORIES

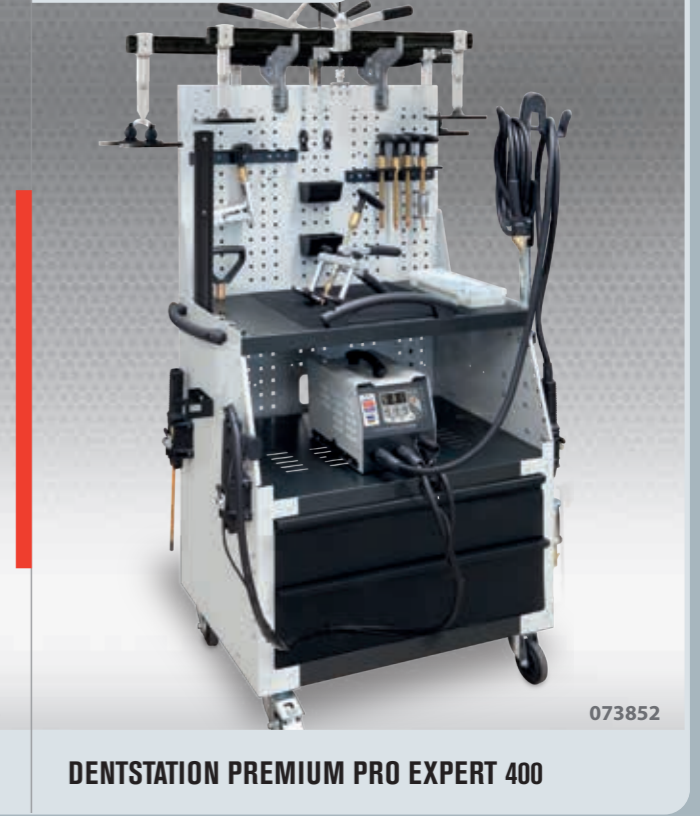

073852

DENTSTATION PREMIUM PRO EXPERT 400

STEEL & ALU ACCESSORIES



073869

DENTSTATION PREMIUM PRO COMBI ARCPULL

STEEL & ALU ACCESSORIES



076020

DENTSTATION PREMIUM PRO EXPERT 400 + ARCPULL 200, 350

NEW

PULLING SYSTEMS



Youtube

DRAW ALIGNER

Équerre de tirage - Draw aligner - Schnellausbeul-Richtausleger 052475

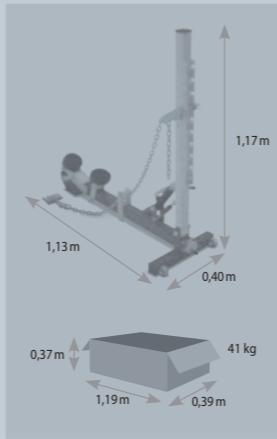
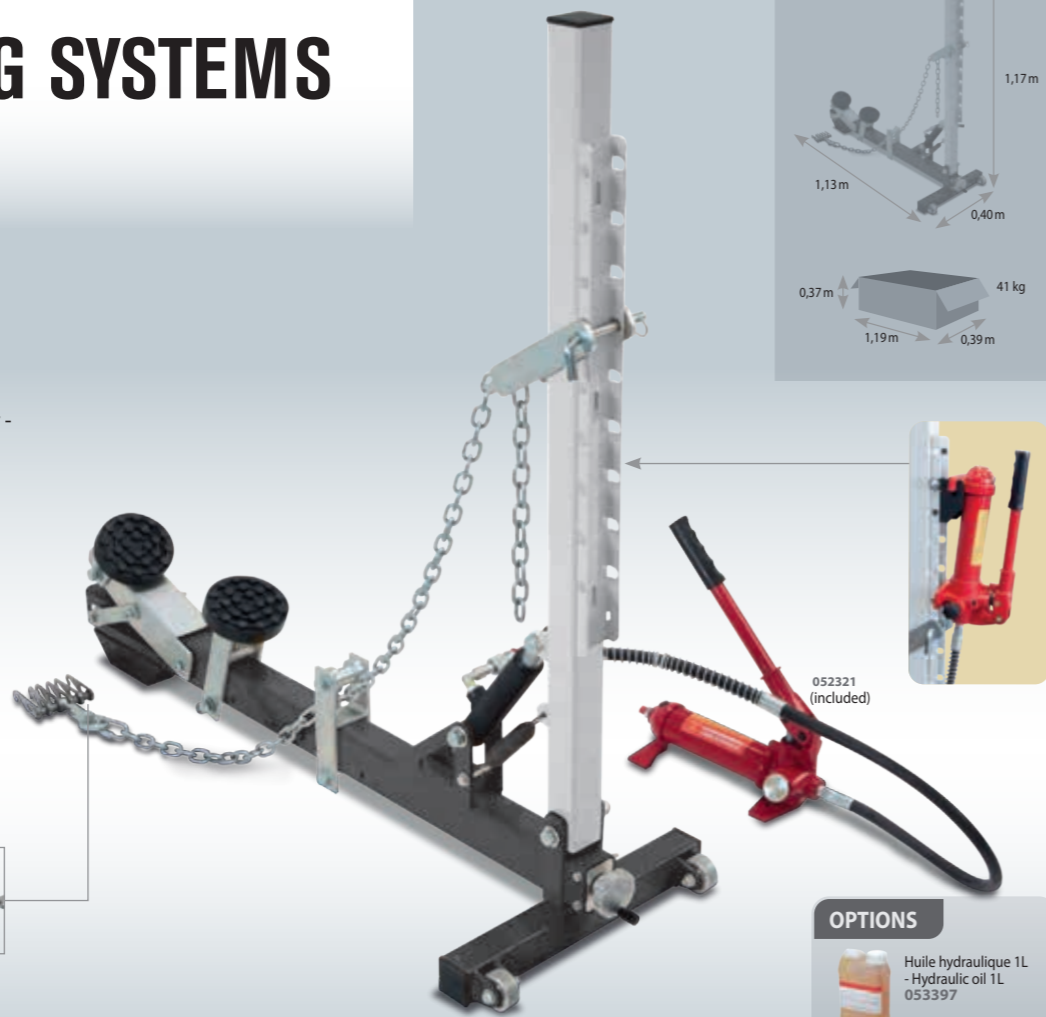
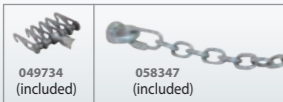
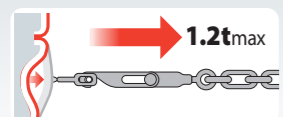
**OPTIONS****INCLUDED**

Câle pour bas de caisse - Wedge for rocker panel

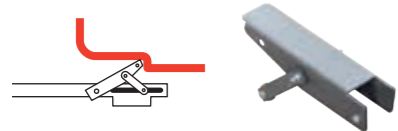

Kit patins pour bas de caisse - Pads kit for rocker panel

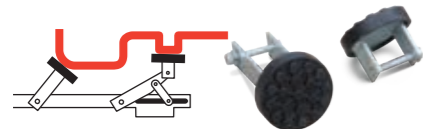
**OPTIONS**

Bras de bas de caisse - Rocker panel arms for draw aligner - Abstütztraverse für Richtausleger

052581

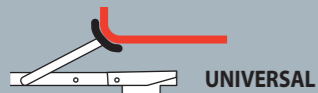
**UNIVERSAL**

7 kg

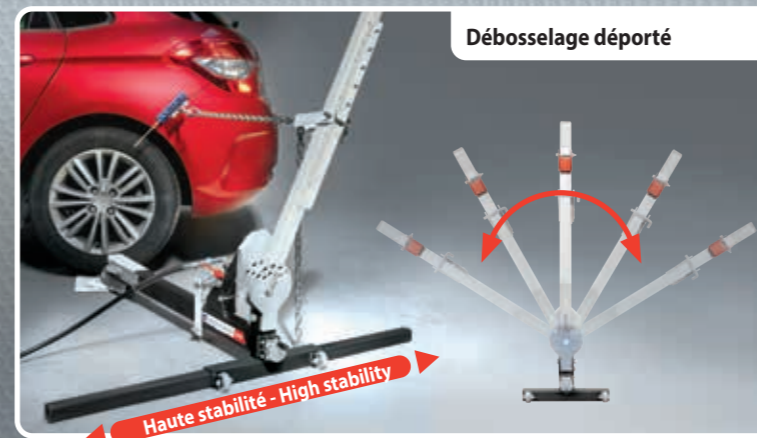
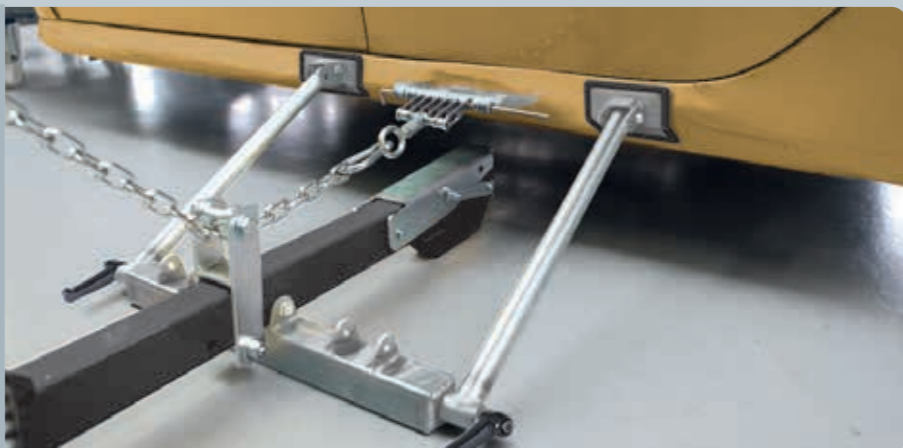

Débosselage déporté

Haute stabilité - High stability

DRAW ALIGNER PRO

069244

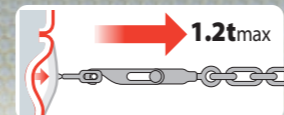

049734 (included)

058347 (included)

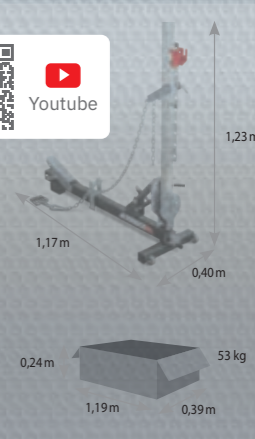
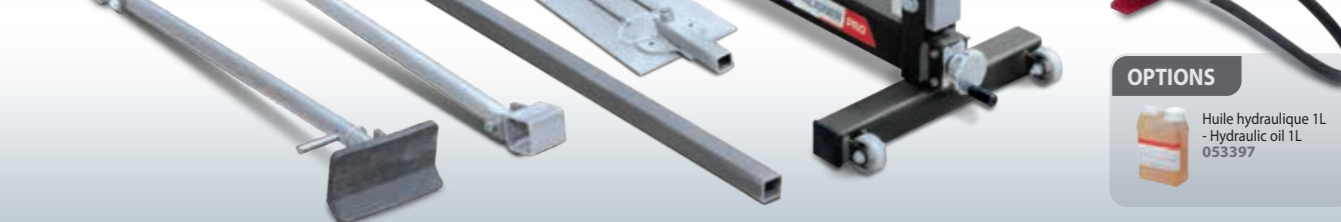
**OPTIONS****INCLUDED**

Câle sous roue - Plate under the wheel

076693



Câle pour bas de caisse - Wedge for rocker panel

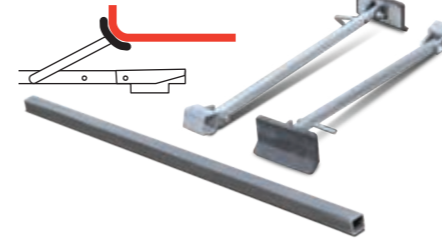

Kit bras de bas de caisse et barre de stabilisation - Rocker panel arms and stabilisation bar

**OPTIONS**

Kit patins pour bas de caisse - Pads kit for rocker panel

071278



SYSTÈME DE TIRAGE SMART PULLER SILVER
- Smart puller silver pulling system - Schnellausbeul-Richtausleger Smart puller silver

054820

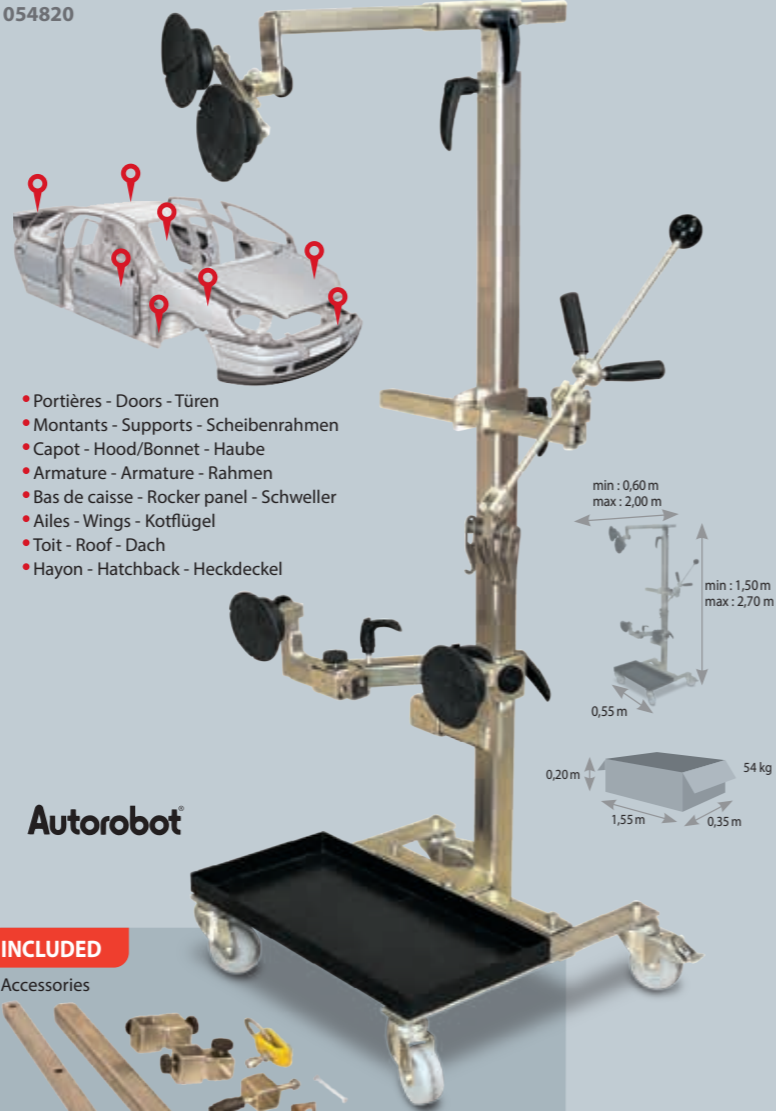
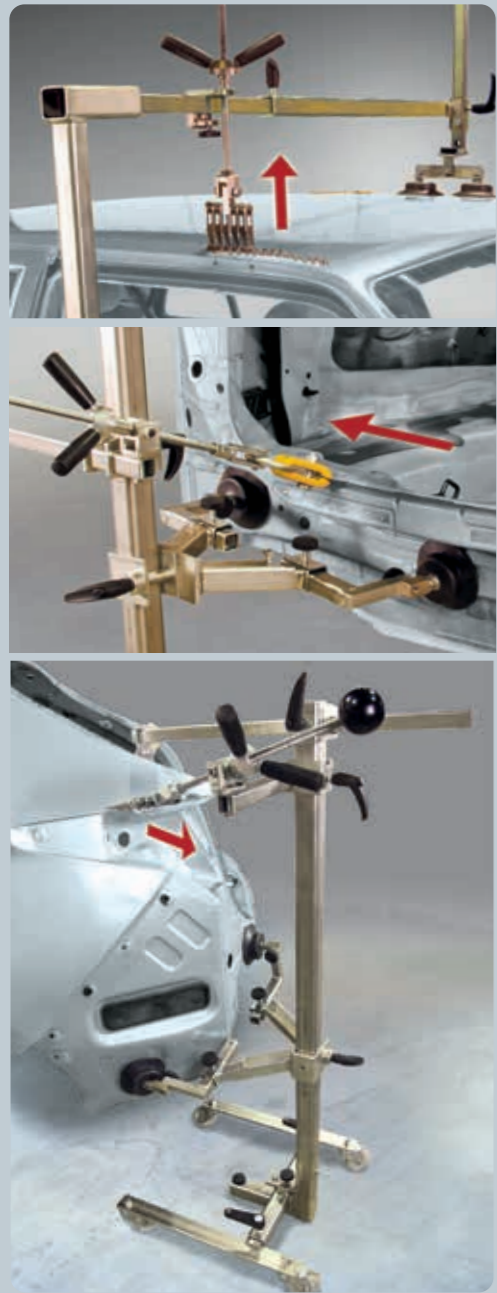

- Portières - Doors - Türen
- Montants - Supports - Scheibenrahmen
- Capot - Hood/Bonnet - Haube
- Armature - Armature - Rahmen
- Bas de caisse - Rocker panel - Schweller
- Ailes - Wings - Kotflügel
- Toit - Roof - Dach
- Hayon - Hatchback - Heckdeckel

min: 0,60 m
max: 2,00 m

min: 1,50 m
max: 2,70 m

0,55 m

0,20 m

1,55 m

0,35 m

54 kg

Autorobot

INCLUDED

Accessories



COFFRET VÉRIN HYDRAULIQUE - Hydraulic cylinder kit - Hydraulischer Drucksatz

MADE IN CHINA

BASIC 4T
052345



BASIC 10T
052338



PRO 4T
057432



PRO 10T
057449



OPTIONS

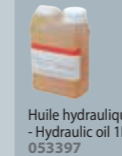

Huile hydraulique 1L
- Hydraulic oil 1L
053397

BARRE D'ANCRAGE - Anchor bar - Türspanner

MADE IN TAIWAN

053045

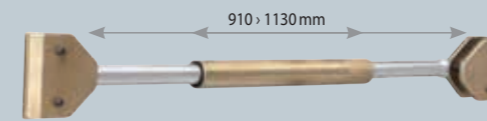

053052

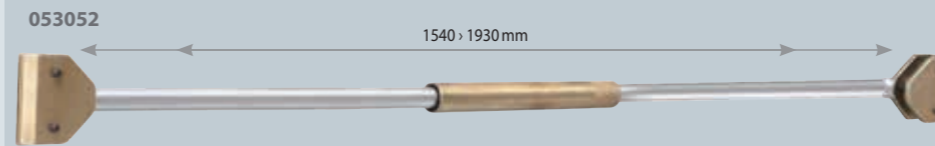

ELECTRO POWER - Zug-Druckpresse

Non commercialisable en France

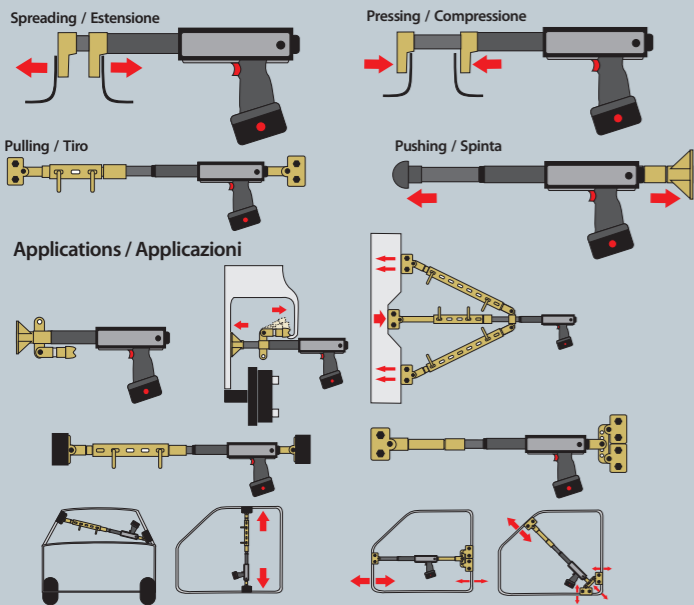

with accessories:
057425

PULLING POWER: 5 Ton.
PUSHING POWER: 5 Ton.
PISTON
STROKE: 130 mm



MADE IN ITALY

INCLUDED



Standard kit: 425x620x210 mm
Standard kit Total weight: 18 kg
057401

Li-Ion battery (included)
058514



Accessories kit: 425x620x150 mm
Accessories kit Total weight: 20 kg
057418

MESURES - Measuring tools - Vermessung

BODYMETER, Mechanical measurements

052130

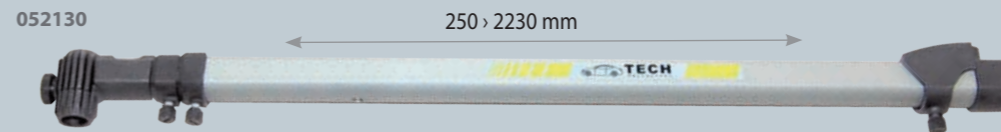

GYSMETER, Electronic measurements

052093

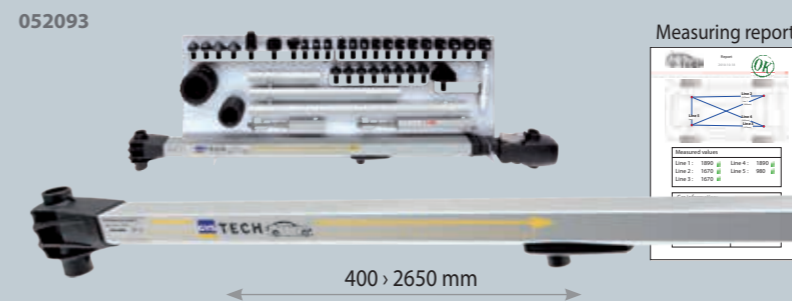

Measuring report

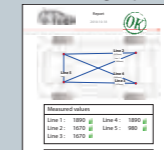

Light weight measuring arm with an easy to read digital display



PINCE PIVOTANTE
- Swivel clamp

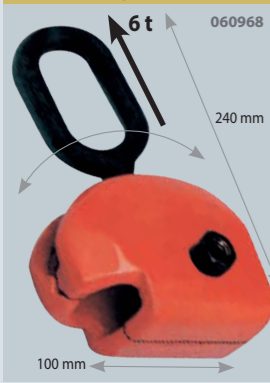

PINCES DE TIRAGE - Frame Straightening - Ziehwerkzeuge

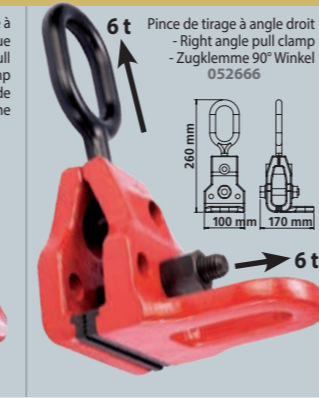
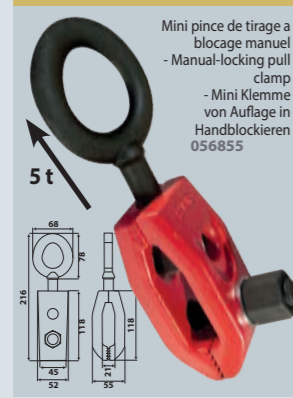

CROCHET DE TIRAGE - Frame Straightening - Ziehwerkzeuge

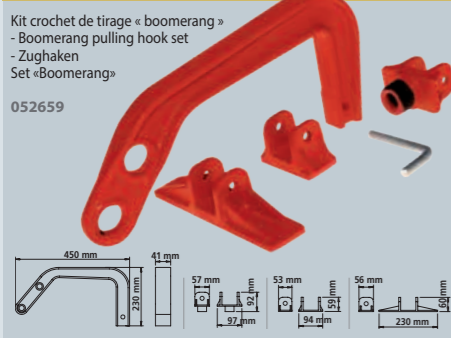

PASSAGE DE ROUE - Arch hooks

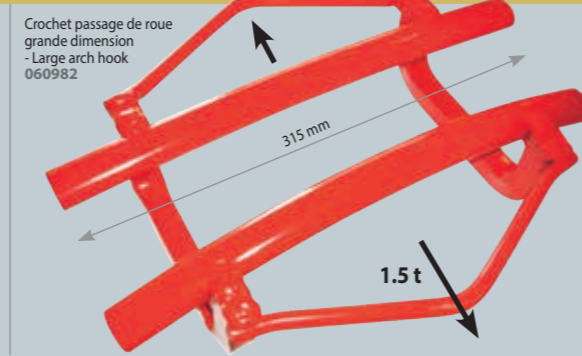
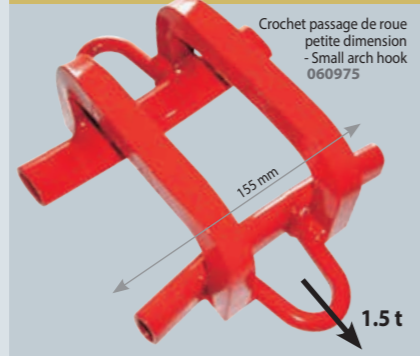

CHAÎNES DE TIRAGE - Frame Straightening - Ziehwerkzeuge

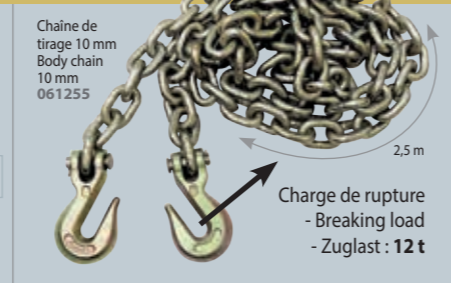
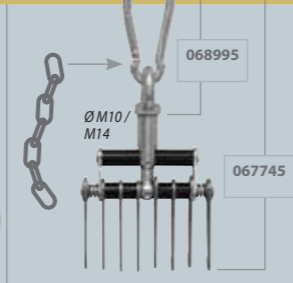
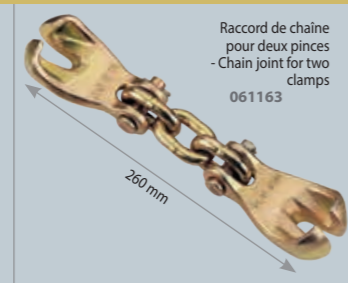
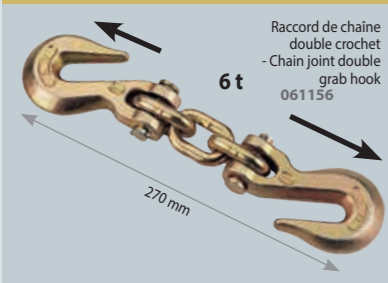

PINCES DE TIRAGE LARGES - Wide pull clamps

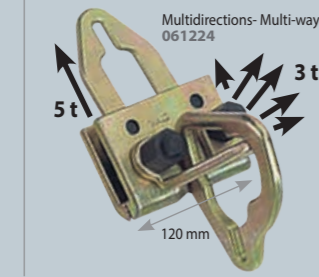
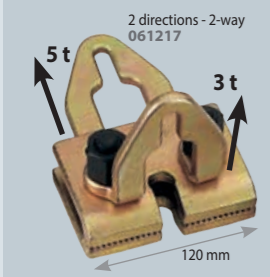

PINCES DE TIRAGE FAIBLE LARGEUR - Small pull clamps

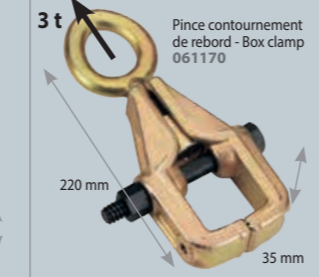
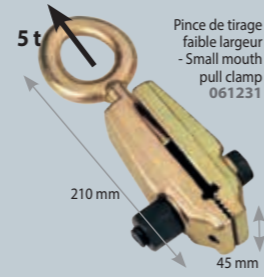
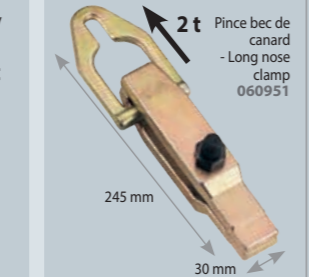

PINCE DE TIRAGE MULTIPLE
- Multiple pull clamp

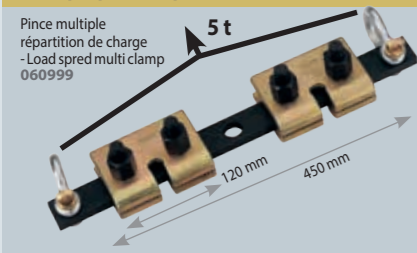

PINCE CISEAUX LARGEUR
45 mm - 45 mm scissors clamp



PINCE DE TIRAGE POUR ANGLE 90°
- 90 Degree corner clamp



PINCE DE TIRAGE TYPE C
- C type clamp

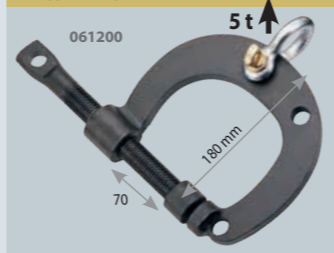

KIT MARTEAU À INERTIE - Inertia hammer kit - Ausziehhammer kit

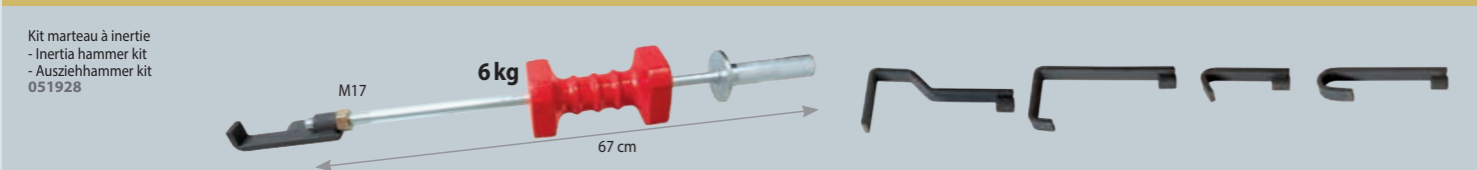

SATELLITE INTELLIGENT - Smart Satellite - Satellit Komplett-Kit

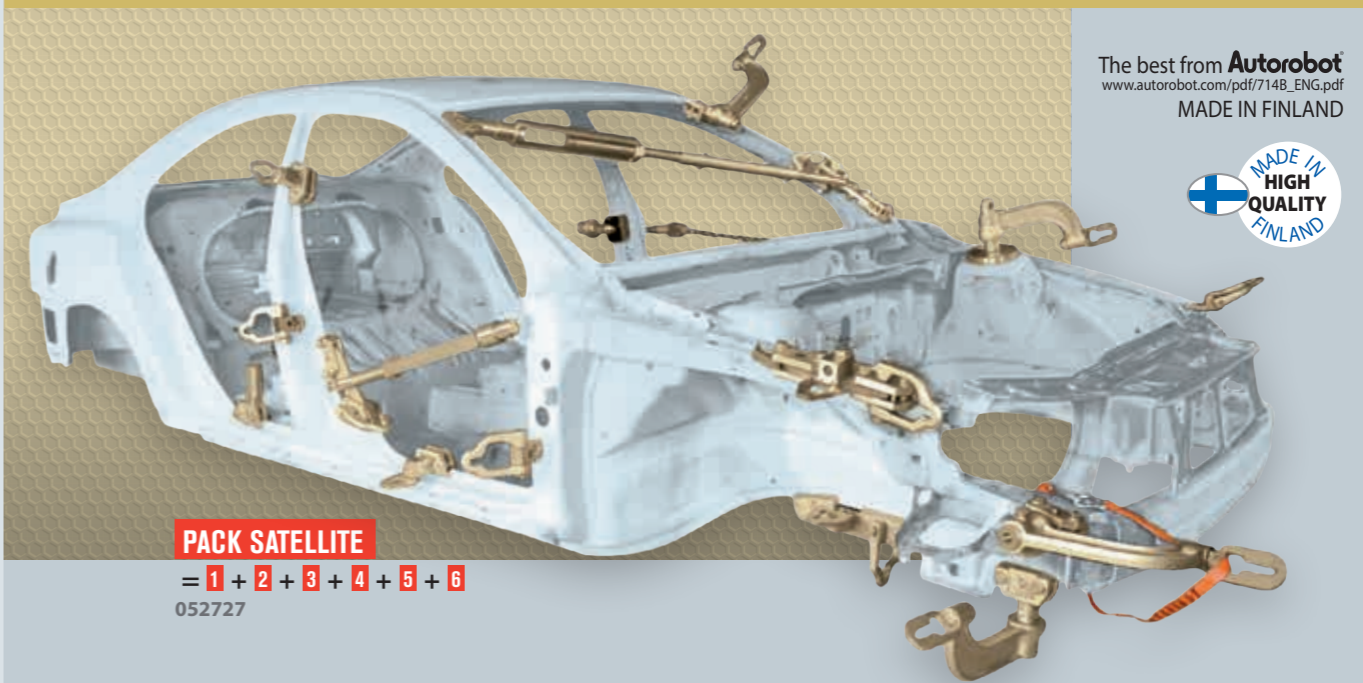

The best from **Autorobot**
www.autorobot.com/pdf/7148_ENG.pdf
MADE IN FINLAND



PACK SATELLITE
= 1 + 2 + 3 + 4 + 5 + 6
052727

1 SATELLITE
- Satellite - Satellit Basisbügel-Set



2 KIT MAC PHERSON (A)
- Mac Pherson Kit - Befestigungs-Kit-Federbein (McPherson)

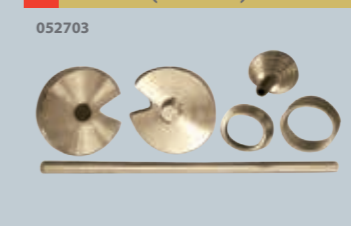

3 BARRE POUR TIRER/POUSSER
- Push/Pull Bar - Zug/Druck-Stangenset



4 SATELLITE (B)
- Bügelverlängerung

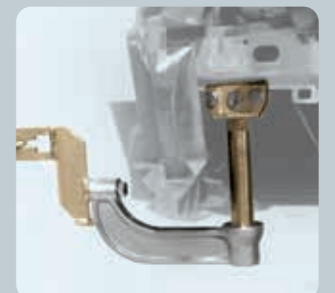
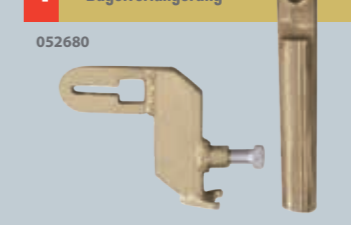

5 SANGLE DE SÉCURITÉ
- Safety Strap - Sicherungsgurt

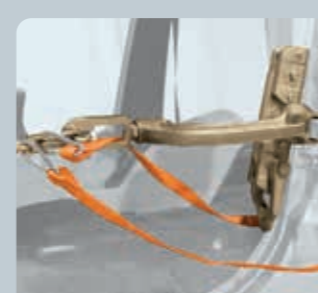

6 DOUBLE PINCE SATELLITE (C)
- Double Clamp Satellite - Satellit Doppelklemme



PINCE DE TIRAGE MULTI-USAGE
- Versatile pulling clamp - Multifunktions-Zugklemme



POWER-PULLER 4T

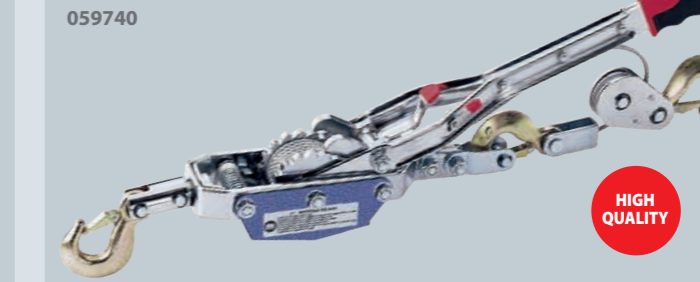



Débosselage rapide et sans peinture
- PDR: Paintless Dent Repair
- Lackschadenfreies Ausbeulen

PAINTLESS DENT REPAIR

INDUCTEUR DÉBOSELAGE - Dent Pulling Inductor - Dellenmatrix

GYSDUCTION AUTO

+ Dent pulling inductor
054776

= GYSDUCTION AUTO DENT REPAIR
054981



MADE IN FRANCE



Licensed by BETAG.Innovation

INSPECTION CARROSSERIE - Dent Pulling Inductor - Ausbeul Induktor

Planche flexible pour inspection de la carrosserie - Ausbeul-Matrix
Ø 800 mm
059122

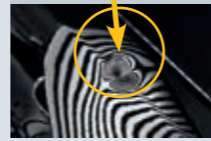
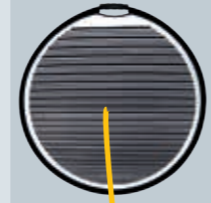

OPTION
Spray refroidisseur - Freezer spray
-50 °C
400 ml
(x 12)
048898

⚡	⚡	⚡	Freq.	INTEGRATED TECHNOLOGY		❄️	Cable (m)	⚙️	👤
50 Hz	A	W	kHz	PFC	FV	Liquid Cooling	Inductor	cm	kg
230V, 1~	16	2 400	35+120	▪	▪	—	2, 2,5	22 x 36 x 27	7,5

KIT MAGNÉTIQUE DE DÉBOSELAGE SANS PEINTURE - Paintless Dent Repair magnetic kit - Magnetisches Ausbeul-Kit

053168

EXELTOOLS



LAMPES DE DÉBOSELAGE - Paintless Dent Repair lamps - Ausbeullampe

ULTRA LIGHT CARBON X40 PW
053175

EXELTOOLS



KIT DÉBOSELAGE SANS PEINTURE - Dent Pulling Kit (paintless) - Dellenausbeulhebel-Set

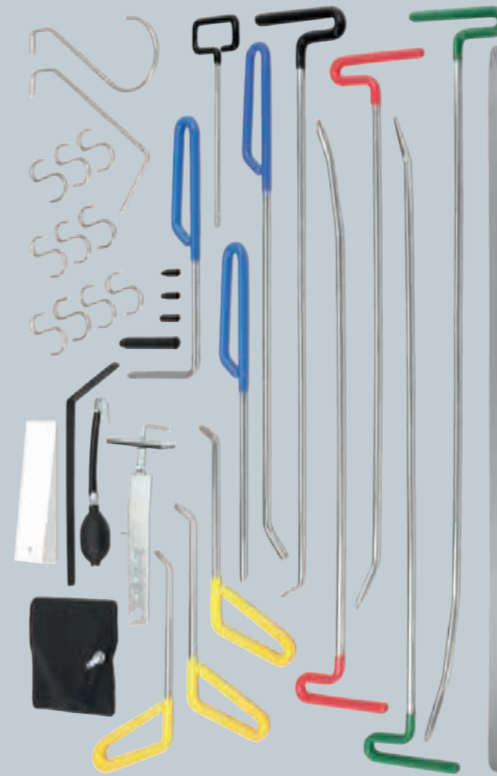

33 parts

051959



KIT DE 6 COINS DE FRAPPE - Set of 6 pencil punches - Beulenstemmer-Satz mit 6 Tefloneinsätzen



052888



MADE IN FRANCE



MARTEAU INERTIE PNEUMATIQUE - Pneumatic inertia hammer - Unterdruck-Schlaghammer



051904

MARTEAU À INERTIE À VENTOUSES (POMPAGE MANUEL) - PUMP AIR SUCTION SLIDE HAMMER - Man. Unterdruck-Schlaghammer



048683

KIT COUSSINS GONFLABLES - Air Cushion Kit - Luftpolster-Spreizkissen-Satz



051942



Débosselage rapide et sans peinture
- PDR: Paintless Dent Repair
- Lackschadenfreies Ausbeulen

PAINTLESS DENT REPAIR

BARRETTES ANNEAUX PLASTIQUE Plastic Multipads Ösen-Klebe pads

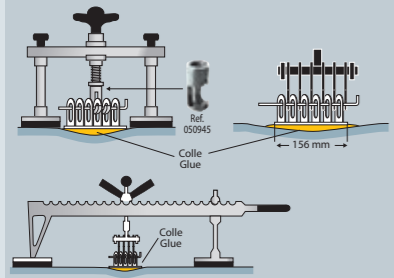
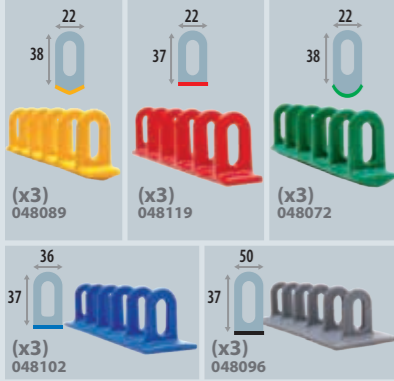

GLUE PULLING KITS

GYSMART GLUE PULLING KIT

NEW



GYSMART GLUE PULLING KIT PLUS

NEW



Workstation 054233	Set of pincil punches with 6 teflon tips 052888	Infrared thermometer 052994	Heat Gun 066311	Levelling bar 050693	6 Gripping multihook head 049734	3 Lifting rods 150/300/500 mm 050792	Set of 3 conical plastic multipads 048096 048072 048089 048119 048102	Inertia hammer 057906	Set of 6 glue tips 050952	Glue Puller PRO 058699	Glue Puller PRO Export 059160	33PC Paintless dent repair kit 051959	PDR Light ultra light carbon X40PW 053175	Mini puller 050921	Aluminium clamp 2 050945
--------------------	---	-----------------------------	-----------------	----------------------	----------------------------------	--------------------------------------	---	-----------------------	---------------------------	------------------------	-------------------------------	---------------------------------------	---	--------------------	--------------------------

GYSMART GLUE PULLING KIT 076051						✓									
GYSMART GLUE PULLING KIT EXPORT 076105						✓								✓	
GYSMART GLUE PULLING KIT PLUS 076082							✓								✓
GYSMART GLUE PULLING KIT PLUS EXPORT 076129						✓									✓



TRUCK TOOLS

TROLLEY IW1
Impact wrench trolley -
Support de clé à choc

max 6.5 bar

max 20 kg

063136

OPTIONS

Huile hydraulique - Hydraulic oil 1l 053397

Suppression du poids, des vibrations et du couple
- Weight, vibrations & torque suppression



Liberté de mouvement - High dexterity

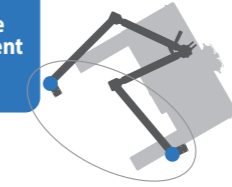

Grande maniabilité et stabilité
- High maneuverability & stability



Clé à choc - Impact wrench
max 20 kg
Fixation
36 x 36 mm
→ 44 x 44 mm

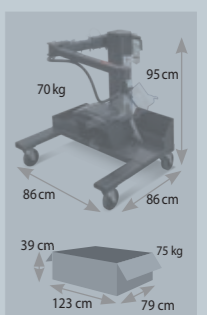

MULTITOOL TRUCK

SAFE EN 14238 + A1

max 200 kg

067158

INCLUDED

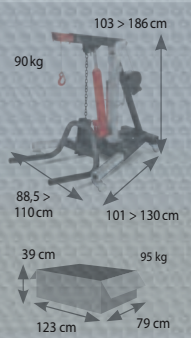
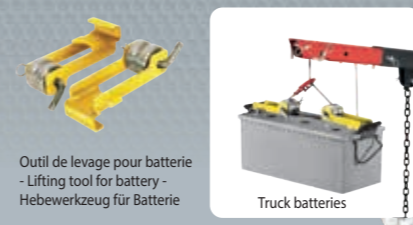

HEALTH CARE

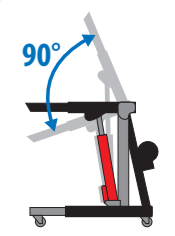
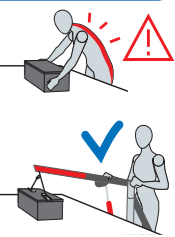

41

TRUCK TOOLS



SPOT LIFT

MOBILE LIFTS

SPOT LIFT EASY

max Air 8 bar **SAFE EN 1494**
max 2.2 t

HEALTH CARE



Haute stabilité - High stability



Included 220 bar 053588

SAFE EN 1494

OPTIONS



Huile hydraulique - Hydraulic oil 11 053397

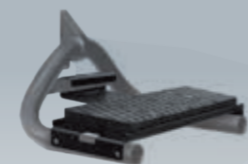

Outil de levage pour bas de caisse - Rocker panel lifting tool - Auflage für Seitenschweller 053236

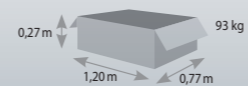

SPOT LIFT PRO

max Air 8 bar **SAFE EN 1494**
max 2.2 t

053557

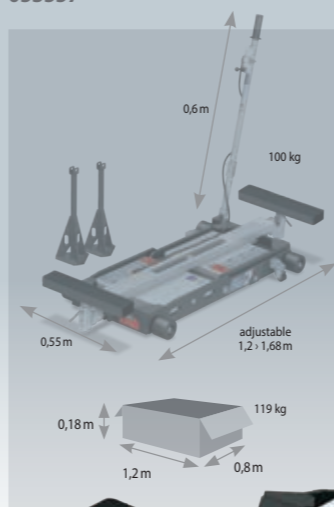

SPOT LIFT PRO MOB

max Air 8 bar **SAFE EN 1494**
max 2.2 t

055896



60 cm (max)
14 cm (min)

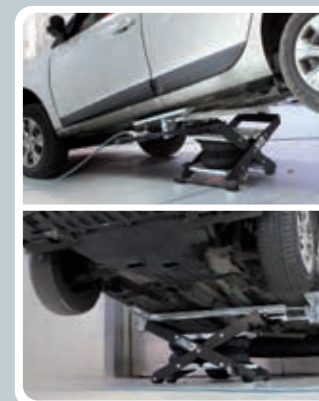

OPTIONS

Réhausseur pour 4x4 et utilitaires - Height adjuster for 4x4 & utility vehicles - Erhöhung f. 4x4 und Leicht-LKW



Patins - Pads for Audi & BMW (x 2) 053717

Rampes - Ramps 700 x 200 x 80 mm (x 2) 056787

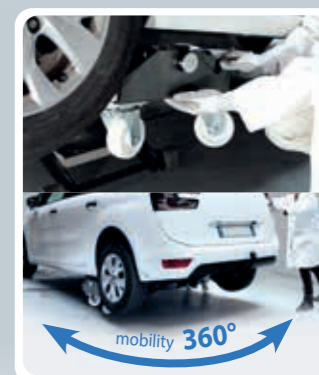

OPTIONS

SPOT LIFT PRO MOB Réhausseur pour 4x4 et utilitaires - Height adjuster for 4x4 & utility vehicles - Erhöhung f. 4x4 und Leicht-LKW



Patins - Pads for Audi & BMW (x 2) 061606

Rampes - Ramps 700 x 200 x 80 mm (x 2) 056787

AUTO ROLL

min 500 mm max 1700 mm (AUTOROLL 1.0m) max 2240 mm (AUTOROLL 1.55m)
2.5 t max

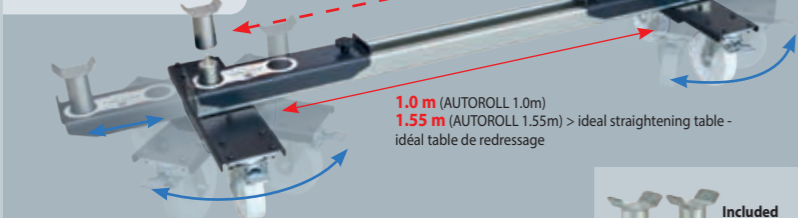

AUTO ROLL 1.0 m / 1.2 t 059047



AUTO ROLL 1.55 m / 1.2 t 063839



AFTER LIFT AUTO ROLL

1 2 **2.5 t max**

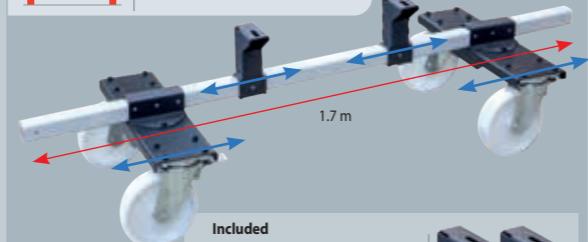

067967

45 Kg

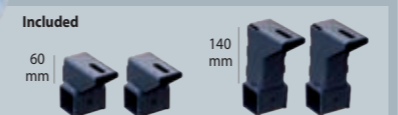

TABOURETS DE MANUTENTION - Wheel trolleys - Radhocker

048768



kg 650kg max

CHARIOTS DE MANUTENTION PRISE SOUS ROUE - Wheel trucks - Kfz-Montagelift, fahrbar

Chariots mécaniques (x 2) - Mechanic jacks (x2) 071995

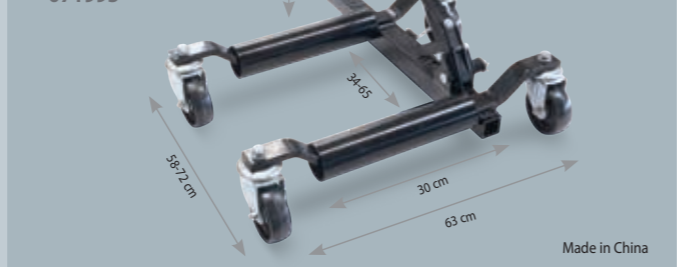

(2x) 16kg 680kg max

Made in China



43

SPOT LIFT

MOBILE LIFTS

42

ERGO LIFT 650

220 V, 1~ **SAFE EN 1493**

max 2 t

056817



Youtube

220 V, 1 ph
0,75 kW

Included
Huile hydraulique -
Hydraulic oil 5l
062160

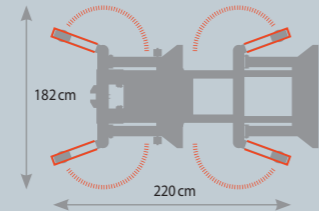

Haute stabilité - High stability

EASY 360° - Déplacements sur 360°

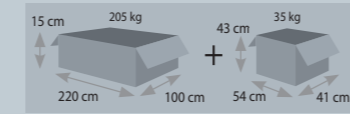

Pack ERGO LIFT 650 + 4 Wheel trolleys (x4)

068544



ERGO LIFT 1000 ROLL

Air 7-8 bars

SAFE EN 1493

max 2.5 t

076792

included:



NEW 11 2022

SAFE EN 1493

Haute stabilité - High stability

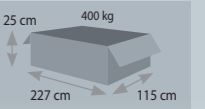

Pack ERGO LIFT 1000 ROLL + wheels

076792



ERGO LIFT 1000 ROLL

067950



QUICK LIFT L520E

062184

220 V, 1 ph
0,75 kW

Included
Huile hydraulique -
Hydraulic oil 5l
062160

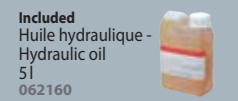

Youtube

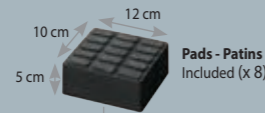
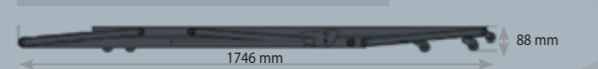
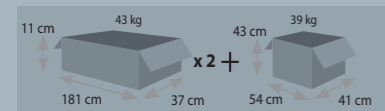

SAFE EN 1493

2.5 t max

OPTIONS

x4 Patins à rainures
071933

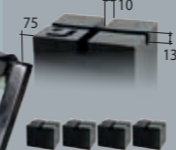

Patins pour SUV -
Pads for SUV
x4
065017



Support mural -
Wall mount
071926



46 cm (max)

Extensions 1680 mm x 2
066328

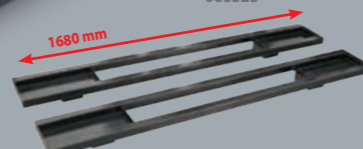

Made in China

AIR JACKS



AIR JACK VAN 2T
058330

2T max

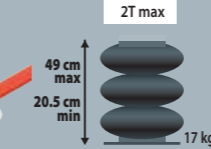

AIR JACK CAR 2T
058323

2T max

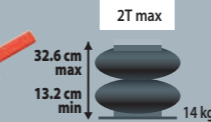

MANUAL WHEEL LIFT

**Lève roue à treuil -
Wheel lift trolley -
Radmontage-Heber**
061385

min : R13 / 135 / 65
max : R22 / 300 / 35
40 kg max

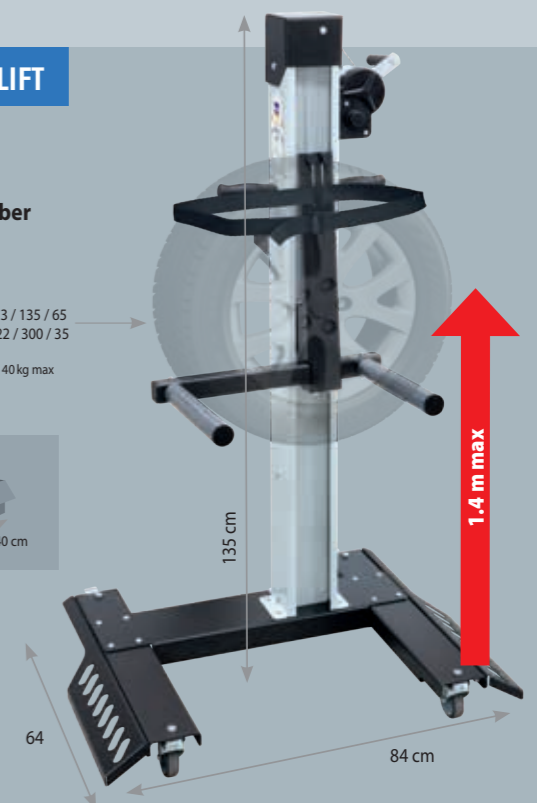
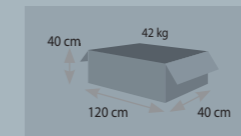

ÉVOLUTION TECHNOLOGIQUE

TECHNICAL IMPROVEMENTS - TECHNISCHE ENTWICKLUNG - MEJORAS TECNICAS

2004

Facteurs d'évolution :
 • Challenge CO2 = faible poids
 • Crash test = ★★★★★
 • Anti corrosion = nouveaux revêtements
 • Esthétique et visibilité plus sophistiquées.

2023

Evolution factors :
 • CO2 Challenge = low weight
 • Crash test = ★★★★★
 • Anti-corrosion = new coatings
 • Improved aesthetics and demand for better occupant visibility.

Entwicklungsfaktoren :
 • CO2 Challenge = geringes Gewicht
 • Crash-Test = ★★★★★
 • Anti-Korrosion = neue Beschichtung
 • Modernes Technik-Design.

Fattori di evoluzione :
 • Sfida CO2 = basso peso
 • Crash test = ★★★★★
 • Nuovi rivestimenti = anticorrosivi
 • Estetica e visibilità più sofisticate

2004

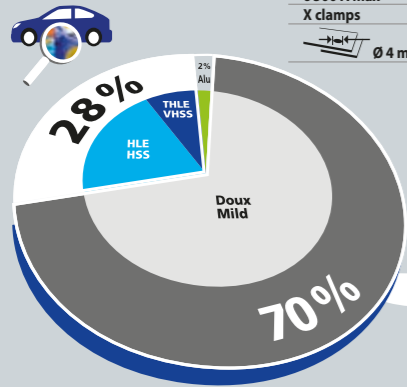

OLD SOLUTIONS
 Traditional machines
 180 daN max
 6 500 A max
 X clamps
 Ø 4 mm max

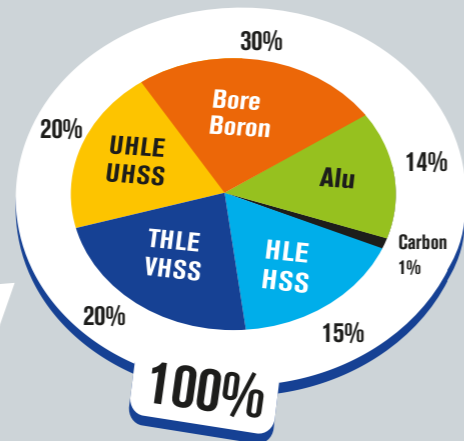

2023

GYS SOLUTIONS
 INVERTER Technology
 550 daN max
 14500 A max
 X & C clamps
 Liquid cooled system
 Ø 10 mm

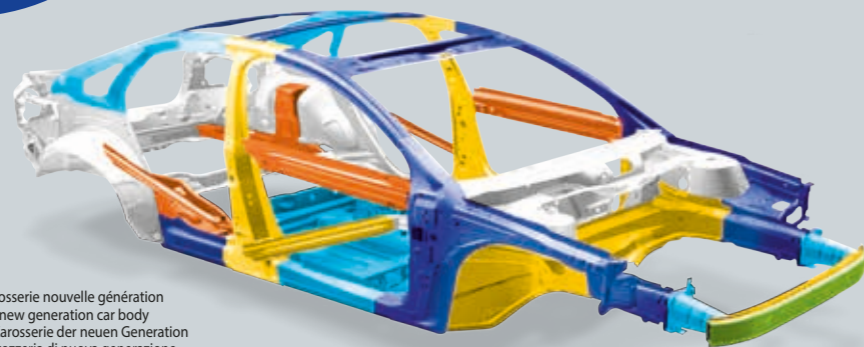

Exemple de carrosserie nouvelle génération
 • An example of new generation car body
 • Beispiel einer Karosserie der neuen Generation
 • Esempio di carrozzeria di nuova generazione

- Mild - Doux
- HSS - HLE
- VHSS - THLE
- UHSS - UHLE
- Bore - Boron
- Aluminium

HOMOLOGATIONS PRODUITS

MANUFACTURER APPROVALS / COMPLIANCE - PRODUKT HOMOLOGATIONEN - PRODOTTI APPROVATI



Product	Volkswagen Group	Jeep	Mercedes	Smart	Dacia	Renault	Volvo	GM	Tata	Peugeot	Kia	Land Rover	Ford USA	Honda USA	BYD
DENT PULLER															
RESISTANCE SPOT WELDERS															
MIG / MAG															
PLASMA															
INDUCTIVE TIG															



RANGE

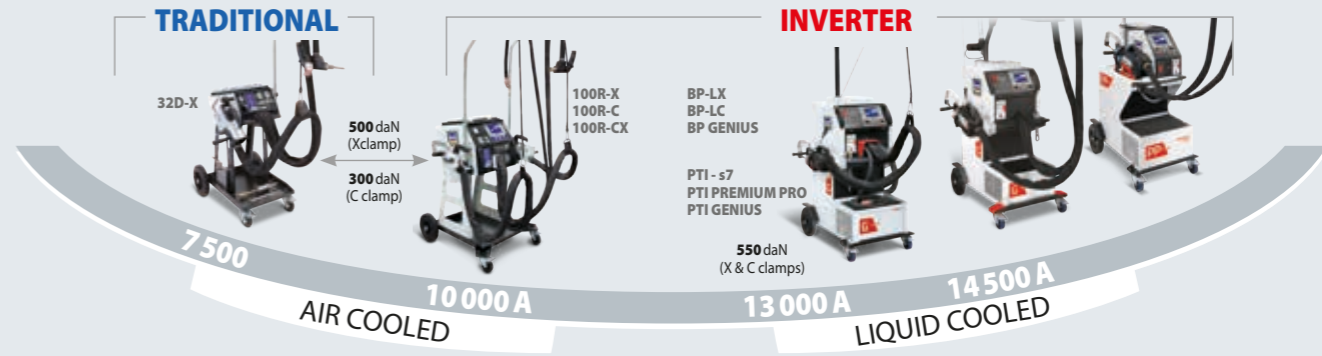

ENIUS	32 D	100 R	BP / BP GENIUS	PTI-s7	PTI PREMIUM PRO	PTI GENIUS
Doux - Mild	•	•	•	•	•	•
HLE/THLE - HSS/VHSS	X	•	•	•	•	•
UHLE/BORE - UHSS/BORON	X	Difficult	•	•	•	•
Nombre de points - Number of spots 10 spots/min	100 5	150 10	no limit 95	no limit 60	no limit 60	no limit > 200
Inverter Technology	—	—	•	•	•	•
EMF Directive 2013/35/UE	—	—	BODY PROTECT TECHNOLOGY	•	•	•
Système de refroidissement - Cooling system	AIR	AIR	LIQUID	LIQUID	LIQUID	LIQUID
Régulation automatique - Automated regulation	I (A) daN irregular	—	• constant	• constant	• constant	• constant
MODE AUTO	—	—	• (LC, LG)	•	•	•
Pince - Clamp	X C X+C	• (32DX)	• (100R-X) • (100R-C) • (100R-CX)	• (BP.LX) • (BP.LC, BP.LG)	•	G clamp
Transformer Inside Clamp	—	—	—	•	•	•
Cables (L)	2,5 m	2,5 m	2,5 m	4 or 6 m	6 m	option
Inclues gun	•	•	•	•	•	•
Cadence de soudage maximale (points/min) - Max welding frequency (spots/min)	10 6	10 2	10 6 10	BP-LC : 10 - BP-LG : 20 2 6 10	10 10	20 20
Fuse	400 V 200/208-240 V	32 A	32 A 40 A 50 A	32 A 40 A 50 A	20 A 40 A 100 A	40 A 50 A

BP BODYPROTECT TECHNOLOGY 2013/35/UE
 UNIQUE ELECTRO-MAGNETIC FIELD PROTECTION by GYS

LA SOLUTION GLOBALE - THE GLOBAL SOLUTION

®BODY PROTECT is a proprietary GYS technology that minimises electromagnetic fields created by the machine.
 Compliant : Directive 2013/35/UE
 Certified by : Laboratory EMITECH

MADE IN FRANCE

Other technologies	GYS BODYPROTECT TECHNOLOGY
B1: 10 < 25 cm (Norm : 3 cm max)	B1: 0 cm (Norm : 3 cm max)
B2: 25 < 35 cm (Norm : 30 cm max)	B2: 5 cm (Norm : 30 cm max) / 4 cm (Norm : 30 cm max)
B3: 35 cm (Norm : 20 cm max)	B3: 0 cm (Norm : 20 cm max)
B4: 35 cm (Norm : 20 cm max)	B4: 0 cm (Norm : 20 cm max)

SPOT WELDING

PORTASPOT 230

6 300 A 120 daN

Air cooled

230V
022256

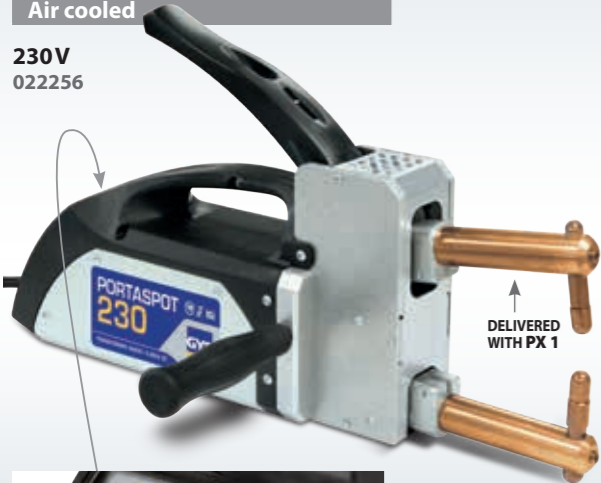

DELIVERED WITH PX 1



ARMS Ø 23 mm

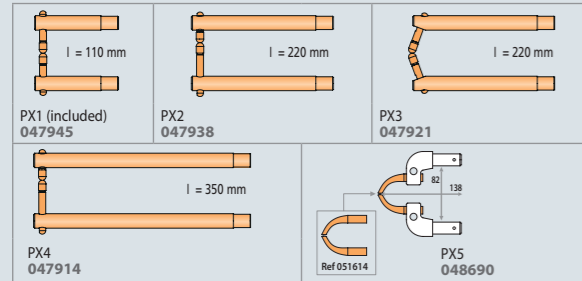

ELECTRODES

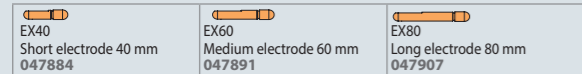

CAPS & ACCESSORIES



50/60 Hz	A	A	A	mm	V	m	mm ²	100% CU	(no arm) cm	kg
1 x 230V	16(D)	6 300	8 900	2+2	2,45	2,5	3x2,5 H05VVf	OK	36x29 x10	10

GYSPOT
32D-X

7 500 A 500 daN

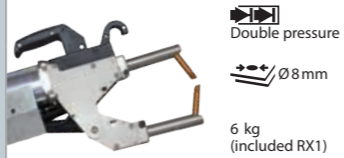

Air cooled

2 x 400V
019881



INCLUDED

32D-X 019881

100R-X 019911
100R-C 019928
100R-CX 022317

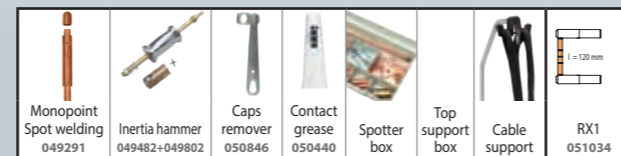

32D-X	100R-X	100R-C	100R-CX	Monopoint	Inertia hammer	Caps remover	Contact grease	Spotter box	Top support box	Cable support	RX1
019881	019911	019928	022317	■	■	■	■	■	■	■	■

GYSPOT
100R-X

10 000 A 500 daN

For mild steel, HSS, UHSS



Air cooled

Traceability software
Save spot welding configuration and export data

3 x 400V
019911



OPTIONS

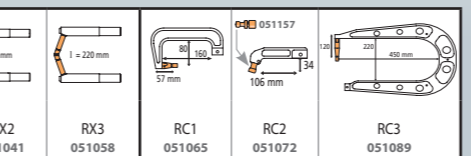

100R-X	100R-C	100R-CX	RX2	RX3	RC1	RC2	RC3
019911	019928	022317	051041	051058	051065	051072	051089

GYSPOT
100R-C

10 000 A 300 daN

For mild steel, HSS, UHSS

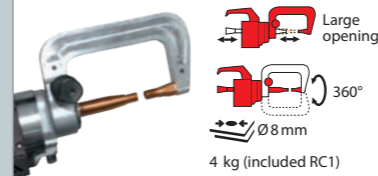

Air cooled

Traceability software
Save spot welding configuration and export data

3 x 400V
019928



GYSPOT
100R-CX

10 000 A 500 daN (X)
300 daN (C)

For mild steel, HSS, UHSS

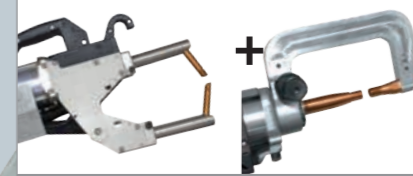

Air cooled

Traceability software
Save spot welding configuration and export data

3 x 400V
022317



MADE IN FRANCE 62135	50/60 Hz	A	A	A	mm	U _o	Cables		100% CU	kg			
							Air Cooled	mm ²					
GYSPOT 32D.X	400V	32 (13 kVA)	6	7 500	10 500	3 + 3	1,2 + 3	11	2,2	200	OK	55 x 75 x 190	78
									2,5	150			
GYSPOT 100R.X GYSPOT 100R.C GYSPOT 100R.CX	3 x 400V	32 (22 kVA) 40 (28 kVA) 50 (35 kVA)	2 6 10	10 000	—	2,5+2,5+2,5	1,5 + 3	16	2,5	200	OK	70 x 99 x 208	108
									2,5	150			
									8	4 x 6 H07RNF		95.5	



GYSPOT BP-LX
13 000 A
 550 daN

For mild steel, HSS, UHSS **Boron steel**

Double pressure
 Ø 10 mm
 6,5 kg (included X1)

Liquid cooled

BP BODYPROTECT
 Unique electro-magnetic field protection
 2013/35/UE by GYS

Traceability software
 Save spot welding configuration and export data

019652

	019652	058804
400V		
Gyspot BP-LX	▪	▪
Monopoint/Spot 049291	▪	▪
Spotter box pro (p.10) 050075	▪	▪
Inertia hammer 049482 + 049802	▪	▪
X1 050501	▪	▪
X4A (x2) + X4B + X4C + X2 020733	▪	▪
Liquid cooling (10l) 052246		(x3)

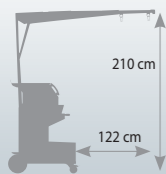

OPTIONS

050068
 x10 (x20: 052239)
 x6 (x6: 049994)
 Caps type A box 048935
 Caps type F box 077119

x18 (x6: 049987)
 x18 (x6: 049970)
 x40 (x6: 049987)
 x40 (x6: 049970)

NEW

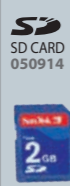

Liquide de refroidissement
 Cooling liquid
 Kühlmittel
 Enfriamento líquido
 Refrigeración líquida
 052246



Housse de protection
 - Protection cover
 - Schutzhaube
 for BP & PTI
 050853



Mandrins pour pistolets - Mandrels for gun - Pistole & Anschlußstücke, Zubehör

S1 < nov 2010 048171
 S2 > nov 2010 048188



OPTIONS BP-LC

GYRO 360° for BP-LC 051737

10-14 kg

GYSPOT BP-LC-s7
13 000 A
 550 daN

For mild steel, HSS, UHSS **Boron steel**

Double pressure
 Ø 10 mm
 6,5 kg (included C1)

Liquid cooled

BP BODYPROTECT
 Unique electro-magnetic field protection by GYS

EDC Automatic C clamp
 Energy Dynamic Control

Traceability software
 Save spot welding configuration and export data

020757

	020757	058798
400V		
Gyspot BP-LC-s7	▪	▪
Monopoint/Spot 049291	▪	▪
Spotter box pro (p.10) 050075	▪	▪
Inertia hammer 049482 + 049802	▪	▪
Contact grease 050440	▪	▪
Caps remover 050846	▪	▪
Arm panel	▪	▪
C1 019140	▪	▪
C2 + C3 + C4 019126	▪	▪
C6 022409	▪	▪
Liquid cooling (10l) 052246		(x3)

GYSPOT PTI-s7
14 500 A
 550 daN

For mild steel, HSS, UHSS **Boron steel**

FUSE 20 A
 Double pressure
 Ø 10 mm
 9,9 kg (included C1)

TRANSFORMER INSIDE

Liquid cooled

EDC Automatic C clamp
 Energy Dynamic Control

Traceability software
 Save spot welding configuration and export data

020894

	4M 020894	4M 067998
220V	6M 022195	6M 020900
Gyspot PTI-s7	▪	▪
Contact grease 050440	▪	▪
Caps remover 050846	▪	▪
Arm panel	▪	▪
C1 021402	▪	▪
C2 + C3 + C4 060821	▪	▪
C6 022409	▪	▪
Gyro 360° 051720	▪	▪
Complete gun kit 067318	▪	▪
Liquid cooling (10l) 052246		(x3)

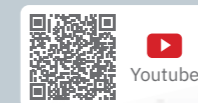
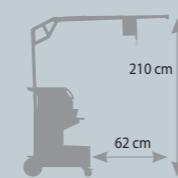

NEW

Very light
 9,9 kg

10-14 kg 059696

CONVERT PTI S-7 > PTI PREMIUM PRO WITH G ARMS

KIT RENOV PTI PREMIUM PRO 220V 072367

400V 072541

C ARMS **G ARMS**

OPTION

200 mm² 1.6m
 300 mm² 1m

Complete gun kit 067318

GYRO 360° for PTI 051720

High stability Compatible gyro

MADE IN FRANCE 62135	50/60 Hz	A D curve	Spots/min (max) ± 2.5+2.5	I RMS A	Uo V	mm			Cables			100% CU	cm	kg
						↕	↔	↔	↔	↔	↔			
GYSPOT BPLX	3 x 400V	32 (22 kVA) 40 (28 kVA) 50 (35 kVA)	2 6 10	13 000	16	2.5+2.5+2.5	1.5+3	2.5, liquid	2.5	8 m, 4x6 HD7RNF	OK	65 x 80 x 205	150	
GYSPOT BPLC-s7														
GYSPOT PTI-s7	3 x 400V	20 (14 kVA)	10	14 500	7.3	2.5+2.5+2.5	1.5+3	4 m, liquid 6 m, liquid	OPTION 067318: 1.6 m, Ø 200 mm ²	8 m, 4x4 HD7RNF	OK	65 x 80 x 230	92	
GYSPOT PTI-s7 220 V														
	3 x	200 208 220 240	10	12 500 13 000 14 500 14 500	6.5 6.7 7.4 7.7			4 m, liquid 6 m, liquid		8 m, 4xAWG8 (SOOW)	OK		98.5	

FOR GYSPOT 32D-X, 100R-X, BP-LX

550 daN

6,5 kg including X1

- DOUBLE PRESSURE
- LIQUID COOLED / REFRIGERATION LIQUIDE
- Ø 10 mm



MADE IN FRANCE

X ARMS Ø 25 mm

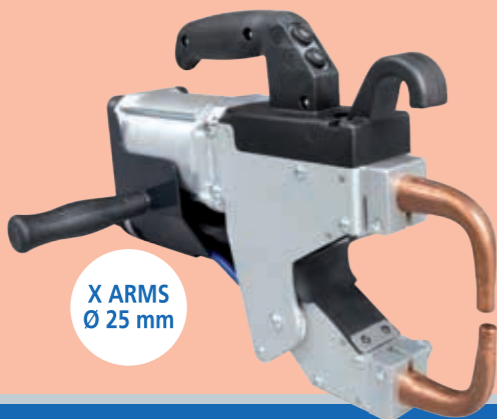

X Arms - Caps Ø13 mm

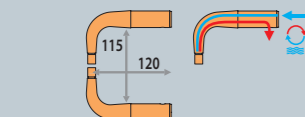

X1 8 bar/550 daN

050501

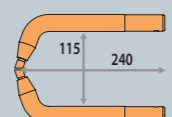

X2 8 bar/400 daN

050518

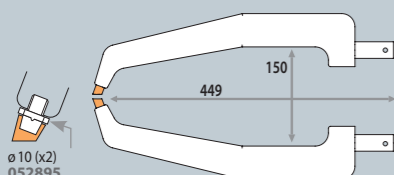

X4 8 bar/120 daN

050532

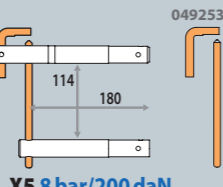

X5 8 bar/200 daN

050549

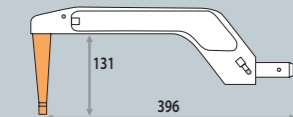

X4A 8 bar/150 daN

020702

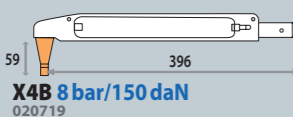

X4B 8 bar/150 daN

020719

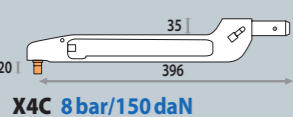

X4C 8 bar/150 daN

020726

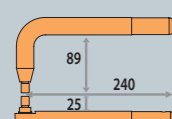

X6 8 bar/400 daN

050587

X4 (A, B & C) combinations



X4A + X4A X4A + X4B



X4B + X4B X4A + X4C



X4C + X4C X4B + X4C

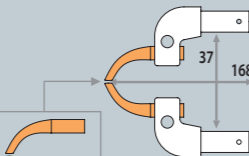

X11 3 bar/150 daN

051607

X ARMS PANELS

X4A (x2) + X5 + X2

022324

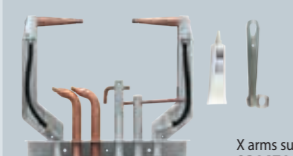

X arms support 021471

X4A (x2) + X4B + X4C + X2

020733

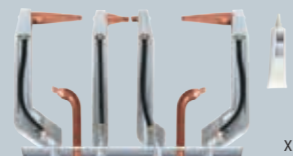

X arms support 021471

Remote control (BP)



Digital screen control Change Mode & Parameters

X clamp control



C clamp control

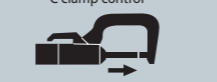

C ARMS PANELS



C2 + C3 + C4

060821

ALL IN 1 BOX



C2 + C3 + C6 + C12 + C9

061316

2 BOXES



C10 + C3 + C5 + C6 + C9

076495

NEW

FOR GYSPOT BP-LC, PTI

550 daN

6,5 kg including C1

- DOUBLE PRESSURE
- LIQUID COOLED / REFRIGERATION LIQUIDE
- Ø 10 mm



MADE IN FRANCE



550 daN

Transformer inside

9,9 kg including C1

- DOUBLE PRESSURE
- AIR COOLED + LIQUID COOLED / DOUBLE REFRIGERATION AIR + LIQUID
- Ø 10 mm

Arm lock pin 062405

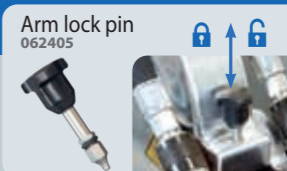

C Arms - Caps Ø13 mm

Classic arms



CLASSIC FINISH

Bras isolés - Isolated arms - Isolierte Bügel



ELECTRICAL INSULATION

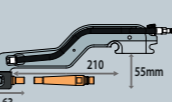

C2 8 bar/550 daN

022386

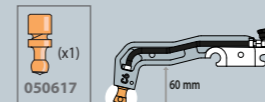

C6 8 bar/300 daN

022409

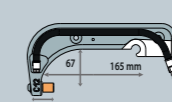

C12 8 bar/550 daN

022997

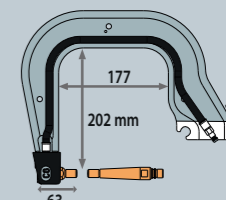

C8 8 bar/550 daN

021440

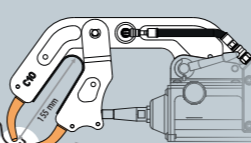

C10 4 bar/150 daN

051638

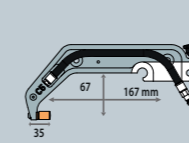

C5 8 bar/550 daN

022393

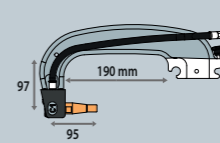

C1 8 bar/550 daN

021402

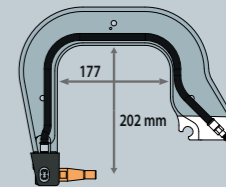

C3 8 bar/550 daN

021419

X Arms - Caps Ø13 mm

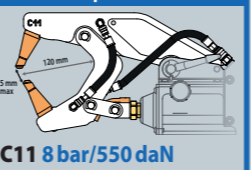

C11 8 bar/550 daN

053649

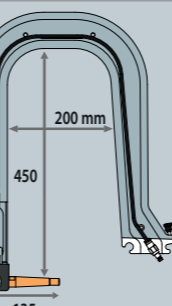

C4 8 bar/550 daN

021426

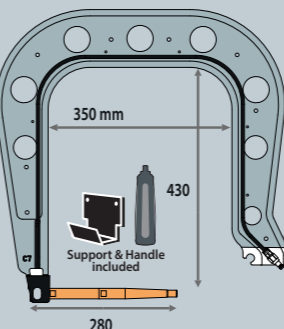

C7 8 bar/550 daN

021433

Option for C7



C7-SA (Small Access) 067684

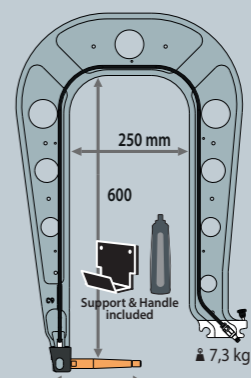

C9 8 bar/550 daN

020078

Option for C9 & C14

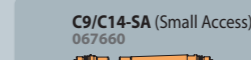

C9/C14-SA (Small Access) 067660

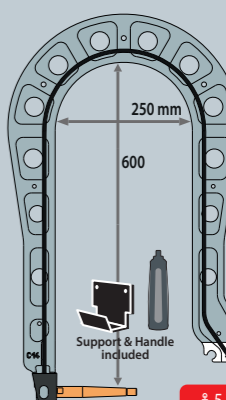

C14 8 bar/400 daN

023543

▲ 5,7 kg 22% saved

SPOT WELDING

GENIUS

G
ARMS
p.60

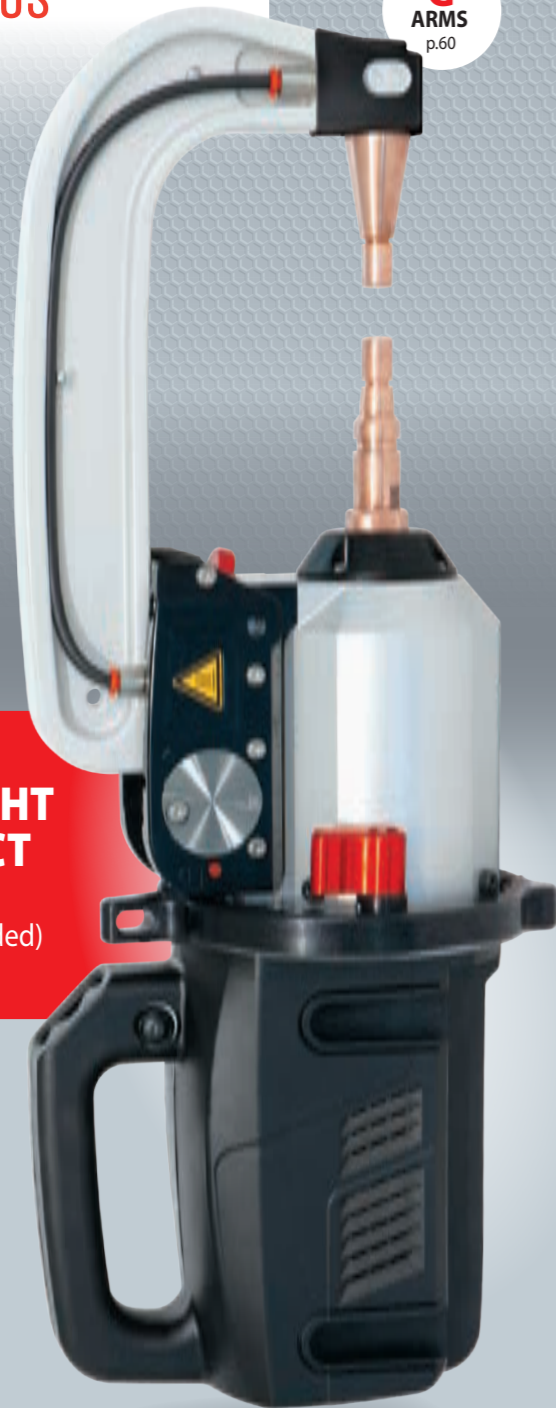

MADE IN FRANCE

ULTRA LIGHT & COMPACT
6.5 kg
(Gyro & G1 included)

550 daN

LIQUID COOLED
REFROIDISSEMENT
LIQUIDE
Ø 10 mm

6.5 kg
(Gyro & G1 included)



FAST OPEN XL

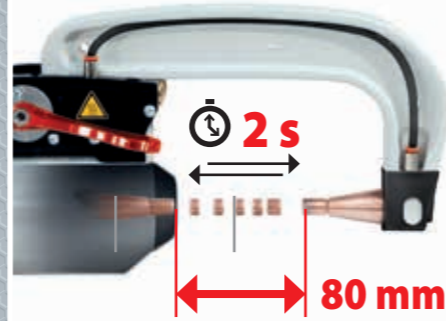

EASY



GYRO INTEGRATED



PERFECT ELECTRICAL CONNECTION



AUTO



**GYSPOT
BP GENIUS**

13 000 A
550 daN

For mild steel, HSS, UHSS | Boron steel

BP BODYPROTECT
Unique electro-magnetic field protection by GYS

Traceability software
Save spot welding configuration and export data

023451



	023550	023451	023499
Gyspot BP GENIUS	220V	400V	
Monopoint/Spot 049291	▪	▪	▪
Spotter box pro (p.10) 050075	▪	▪	▪
Inertia hammer 049482 + 049802	▪	▪	▪
Caps remover 050846	▪	▪	▪
Arm support	▪	▪	▪
G1 022768	▪	▪	▪
G2 + G3 + G4 022896	▪	▪	▪
Liquid cooling (10l) 052246			(x3)



OPTIONS

<p>Caps type A box 048935 x40 (x6: 049987)</p> <p>Caps type F box 077119 x40 (x6: 049970)</p> <p>NEW</p>	<p>x20 (x6: 049987)</p> <p>x6 (x6: 049970)</p> <p>x2 (x1: 050617)</p> <p>073449</p>	<p>SD CARD 050914</p> <p>2 GB</p>	<p>Liquide de refroidissement Cooling liquid Kühlmittel Enfriamento líquido Refrigeración líquida</p> <p>052246</p>	<p>Housse de protection - Protection cover - Schutzhaube</p> <p>for BP & PTI</p> <p>050853</p>	<p>10-14 kg</p> <p>059696</p>
---	---	-----------------------------------	---	--	-------------------------------

MADE IN FRANCE 62135	50/60 Hz	A D curve	Spots/min (max) 2.5+2.5	I _{RMS} A	U _o V	mm			Cables			100% CU	cm	kg													
						⚡	⚡	⚡	⚡	⚡	⚡																
GYSPOT BP GENIUS 220 V	3 x	200 208 220 240	2 6 10	10 500 11 000 12 000 12 500	15 15.5 17 18	2.5+2.5+2.5	1.5 + 3	2.5 m, Ø 200 mm ² , Liquid	2.5 m, Ø 150 mm ² air	8 m 4x16 mm ² (6AWG) 500W	OK	65 x 80 x 205	160														
														GYSPOT BP GENIUS 400V	3 x 400V	32 (22 kVA) 40 (28 kVA) 50 (35 kVA)	2 6 10	13 000	16	2.5+2.5+2.5	1.5 + 3	2.5 m, Ø 200 mm ² , Liquid	2.5 m, Ø 150 mm ² air	8 m 4x6 mm ² H07RNF	OK	65 x 80 x 205	160

SPOT WELDING

G
ARMS
p.60

NEW



MADE IN FRANCE

**FULL
ERGONOMIC**

10.3 kg
(Gyro & G1 included)

550 daN

LIQUID COOLED
REFROIDISSEMENT
LIQUIDE
Ø 10 mm

10.3 kg
(Gyro & G1 included)

Ergonomy & Security

**20°
EASY
HANDLE**

**LOCKING
SYSTEM**

TRANSFORMER INSIDE

GYRO INCLUDED



PERFECT ELECTRICAL CONNECTION

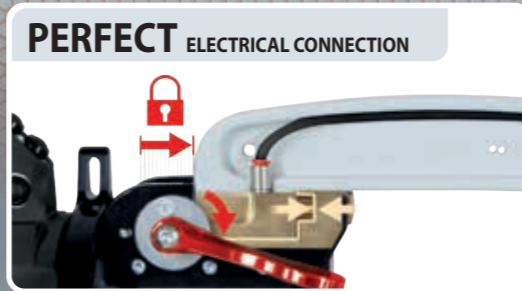

AUTO



XL Balancer

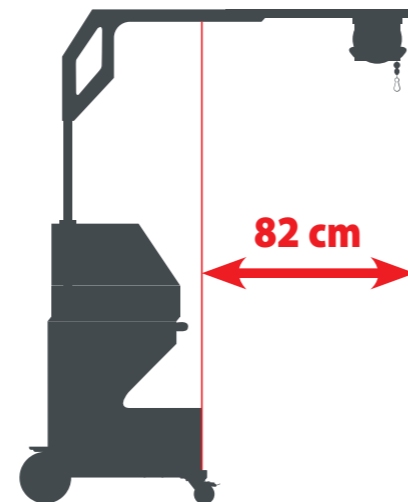

**GYSPOT
PTI PREMIUM PRO**

14500 A
550 daN

For mild steel, HSS, UHSS | Boron steel

— FUSE — 20 A
Double pressure
± ± ± Ø 10 mm
10,3 kg (included G1)

TRANSFORMER INSIDE

Liquid cooled

EDC Automatic G clamp
Energy Dynamic Control

Traceability software
Save spot welding configuration and export data

	6M	
	072206	072183
	220V 400V	
Caps remover 050846		
Arm panel		
G1 022768		

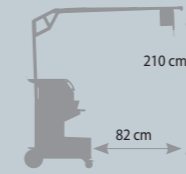

NEW



10.3 kg

OPTIONS

G11
for PTI PREMIUM PRO only

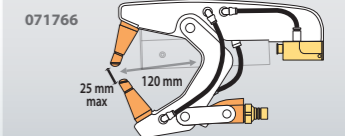

OPTIONS

	Caps type A box 048935	x40 (x6: 049987)	073449		Caps type F box 077119	x40 (x6: 049970)	x2 (x1: 050617)		SD CARD 050914	Liquide de refroidissement - Cooling liquid - Kühlmittel - Enfriamento líquido - Refrigeración líquida	052246
--	---------------------------	---------------------	--------	--	---------------------------	---------------------	--------------------	--	-------------------	---	--------

MADE IN FRANCE	50/60 Hz	3 x	A D curve	Spots/min (max)	RMS A	Uo V	mm	Cables		100% CU	cm	kg
								6 m, liquid	8 m, 4x4 H07RNF			
GYSPOT PTI PREMIUM PRO 220V	200 208 220 240	30 (10-12 kVA) 40 (14-16 kVA) 50 (17-21 kVA)	10	12500 13000 14500 14500	6.6 6.9 7.3 7.9	2.5+2.5+2.5	1.5+3	OPTION 067226; 1.8 m, Ø 300 mm²	8 m, 4x4 H07RNF	OK	65 x 100 x 230	92
GYSPOT PTI PREMIUM PRO 400V	3 x 400V	25 (14 kVA)	10	14500	7.3	2.5+2.5+2.5	1.5+3	OPTION 067226; 1.8 m, Ø 300 mm²	8 m, 4x4 H07RNF	OK	65 x 100 x 230	92

GYSPOT PTI PREMIUM PRO

LIQUID COOLED

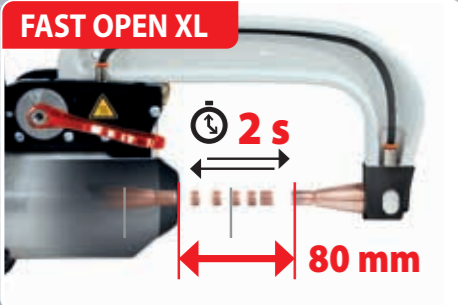

MADE IN FRANCE

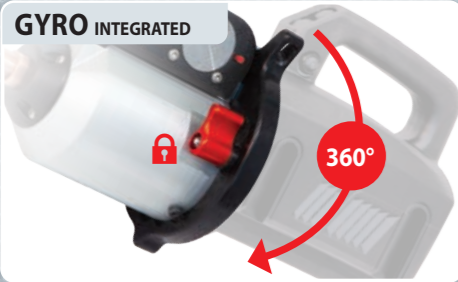

550 daN

LIQUID COOLED
REFROIDISSEMENT LIQUIDE
Ø 10 mm

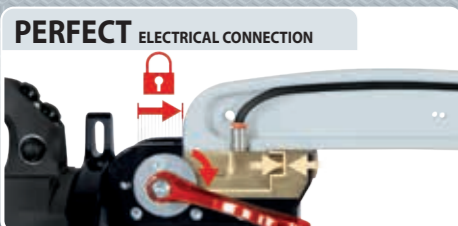

11.3 kg
(Gyro & G1 included)



TRANSFORMER INSIDE

Potence électrique -
Motorised cable support
- Elektrisch verstellbarer
Kabelsupport

NEW DESIGN

Avec contrôle de
commande - with
control command



UPSIDE DOWN
POSITION

OPTIONS

Caps type A box 048935 x40 (x6: 049987)	Caps type F box 077119 x40 (x6: 049970)	SD CARD 050914	Kit WIFI Compatibility: Gyspot Inverter PTI-GENIUS 070691	Liquide de refroidissement - Cooling liquid - Kühlmittel - Enfriamiento líquido - Refrigeração líquida 052246	Housse de protection - Protection cover - Schutzhaube 050853
--	--	-------------------	---	---	---

G ARMS
p.60



GYSPOT PTI GENIUS
14 500 A
550 daN
For mild steel, HSS, UHSS Boron steel
TRANSFORMER INSIDE
Traceability software
Save spot welding configuration and export data

	024854	024878	068001	024892
Gyspot PTI-GENIUS	220V	400V	480V	
Caps remover 050846	■	■	■	■
Arm support	■	■	■	■
G1 022768	■	■	■	■
G2 + G3 + G4 022898	■	■	■	■
Kit gun 067226	■	■	■	■
Liquid cooling (10l) 052246			(x3)	

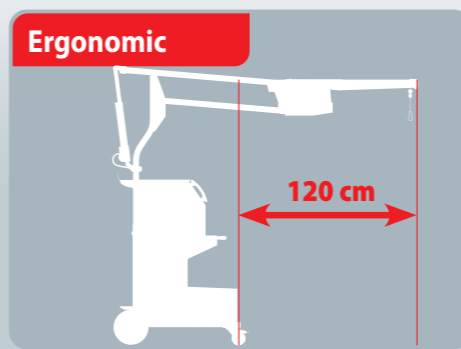

Ergonomic

MADE IN FRANCE 62135	50/60 Hz	A D curve	Spots/min (max) 2.5+2.5	I RMS A	Uo V	mm		Cables		cm	kg
						↕	↔	↕	↔		
GYSPOT PTI GENIUS 220 V	3 x 208-240	50 (17-21 kVA)	20	12 500 13 000 14 500 14 500	6.6 6.9 7.3 7.9	2.5+2.5+2.5	1,5+3	6 m, Liquid	8 m 4xAWG8 (500W)	71 x 90 x 200	100
GYSPOT PTI GENIUS 400V	3 x 400 V	25 (17 kVA)	20	14 500	7	2.5+2.5+2.5	1,5+3	6 m, Liquid	8 m 4x4mm ² H07RN6	71 x 90 x 200	100
GYSPOT PTI GENIUS 480V	3 x 480 V	20 (17 kVA)	20	14 500	7	2.5+2.5+2.5	1,5+3	6 m, Liquid	8 m 4xAWG12 (500W)	71 x 90 x 200	100

Included
Cable support
ULTRA
RESISTANT



ELECTRIC
MOTOR

Control
Commande

Boîte de
rangement pour
électrodes -
Electrode storage
box

6 m

Grande stabilité
- High stability

OPTIONS



FOR GYSPOT BP GENIUS, PTI PREMIUM PRO & PTI GENIUS

G Arms - Caps Ø13 mm

Bras isolés - Isolated arms - Isolierte Bügel

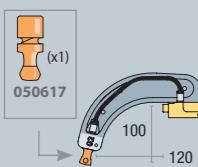

G2
8 bar/300 daN
022775

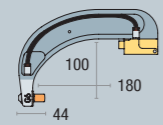

G6
8 bar/550 daN
022812

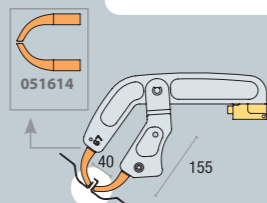

G7
4 bar/150 daN
022829

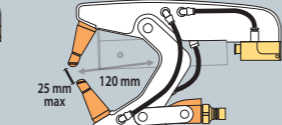

G11
for PTI PREMIUM PRO only
071766

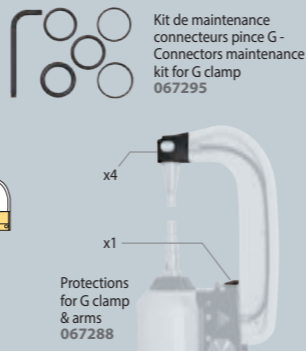

Kit de maintenance connecteurs pince G - Connectors maintenance kit for G clamp 067295

Protections for G clamp & arms 067288

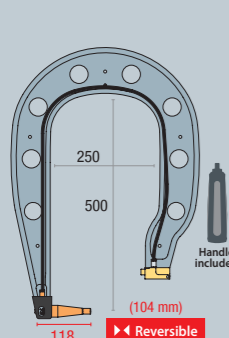

G4
8 bar/550 daN
022799

Option for G4

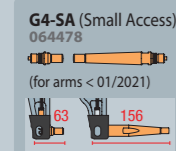

G4-SA (Small Access)
064478
(for arms < 01/2021)

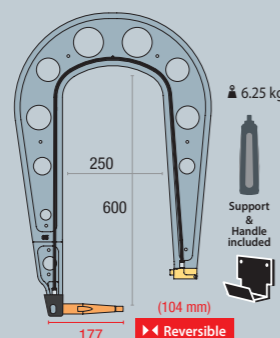

G5
8 bar/550 daN
022805

Option for G5

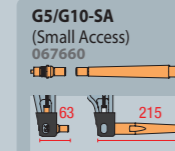

G5/G10-SA (Small Access)
067660

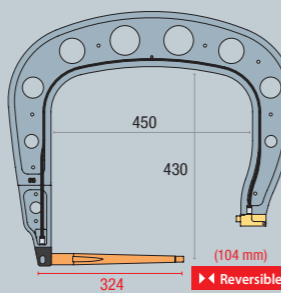

G8
8 bar/550 daN
022836

Option for G8

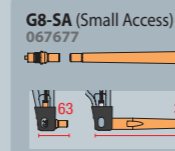

G8-SA (Small Access)
067677

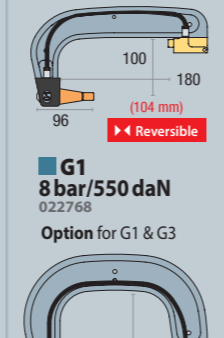

G1
8 bar/550 daN
022768

Option for G1 & G3



G3
8 bar/550 daN
022782



G1/G3-SA (Small Access)
067653
(for arms > 02/2021)

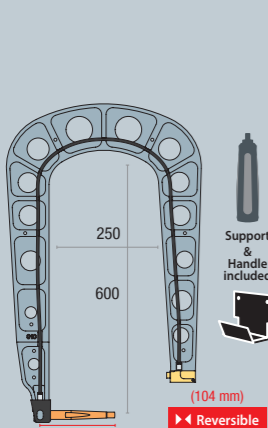

G10
8 bar/400 daN
067165

Option for G10 & G12

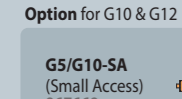

G5/G10-SA (Small Access)
067660

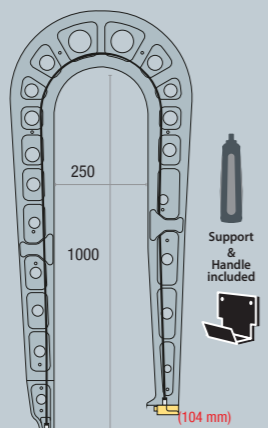

G12
8 bar/300 daN
075238

Option for G10 & G12

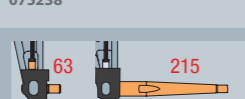

G5/G10-SA (Small Access)
067660



Option SD card 050914



Option PCB 97449C



90284 + 55121



G > X
UNIQUE SYSTEM
BREVETÉ PATENTÉ
AUTOMATIC WELDING FOR X1, X2 & X6

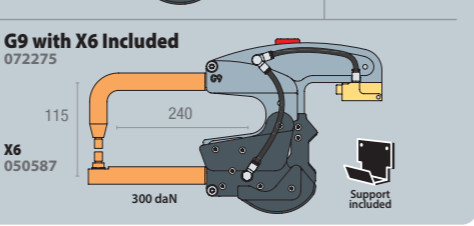
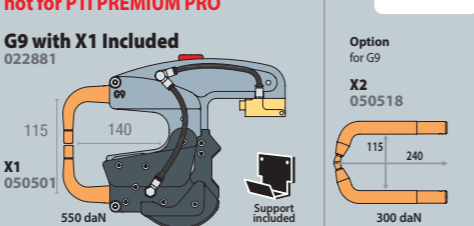

G9 with X1 Included
022881

G9 with X6 Included
072275

Option for G9 X2 050518 300 daN

G ARMS PANELS

- G2 + G3 + G4 022898
- G2 + G3 + G5 063297

KIT SMALL ACCESS GENIUS 077072 **NEW**

for PTI GENIUS & PTI PREMIUM PRO

- G1/G3-SA (Small Access) + G5/G10/C9/C14-SA (Small Access)
- G4-SA (Small Access) + G8-SA (Small Access)

CONSOmmABLES X/C/G - X/C/G Consumables

Type A Cor X clamp Ø 13 mm (x6) 049987	Type D Cor X clamp Ø 13 mm (x10) 058507	TYPE G Ø 13 mm (x10) 059672	Caps type A box 048935 (x40: 049987)	073449	x20 (x6: 049987)	x6 (x6: 049970)	x2 (x1: 050617)	
Type B Cor X clamp Ø 13 mm / Ø 5 mm (x6) 055506	TYPE F For single sided gun Ø 13 mm (x6) 049970	Caps inclinés - Beveled X2, X4, C11 arms Ø 13 mm (x6) 049994	Caps type F box 077119 (x40: 049970)	050068	x10 (x20: 052239)	x6 (x6: 049994)	x18 (x6: 049987)	x18 (x6: 049970)
Graisse contact Contact grease 050440	Caps remover 050846	Europax anti-corrosion 052758	NEW	Monopoint / Spot 049291				

AFFUTEUR DE CAPS PNEUMATIQUE - Pneumatic cap grinder

061484

Lame - Blade 061491

Type A caps

AFFUTEUR DE CAPS - Cap grinder

Lame - Blade 052857

048966

Optimal speed: 400-800 rpm

Youtube

BANC DE TRACTION ARRACHE TÔLE - Steel sheet traction bench - Blech-Zugbank zur Festigkeitsprüfung

052420

052321 (included)

VALISE TEST SOUDURE HLE / THLE - Weld test kit - Schweißtestkit im Hartschalenkoffer

050433

Barre d'arrachage / Traction bar + Acier doux / Mild steel 0.65 (x25) + 1.0 (x25) + Acier HSLA 360 - HLE 0.8 (x25) + 1.5 (x25) + Acier DP600 - THLE/UHLE 1.0 (x25) + Acier FB560 - THLE/UHLE 2.5 (x25)

PROTECTION ANTI-ARC 12 V - Anti-arc protection 12V - Lichtbogenschutz 12V - Protección anti-arco 12V

041318

GYRO 360°

for BPLC/BPLCX 051737

10-14 kg

for PTI 051720

ÉCHANTILLONS DE TÔLES - Sheets set

Acier standard / Standard steel 0.8 (x65) + 1 (x55) + 1.5 (x35) + 2 (x25) + Alu 1 (x45) + 1.5 (x30) + 2 (x20)

055841

CAPTEUR D'EFFORT - Electrode force sensor

052314

KIT DE PURGE RÉSERVOIR - Tank draining kit - Kit zur Tankentleerung

058286

for GYSPOT BPLC-s7 / BPLCX-s7 / PTI-s7

CARTE MÉMOIRE SD - SD memory card

SD CARD 050914

KIT WIFI

for Gyspot Inverter PTI GENIUS 070691

HOUSSE DE PROTECTION - Protection cover - Schutzhaube

for BP & PTI 050853

LIQUIDE DE REFRIGÉRISSSEMENT - Cooling liquid - Kühlmittel - Enfriamento líquido - Refrigeração líquida

052246



RIVETING

PNEUMATIC HYDRAULIC

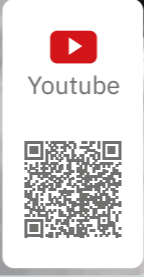

BRAS DE RIVETAGE - RIVETING ARMS - STANZNIETBÜGEL



	HR110	HR210	HR310
	063310	063327	063334
GYPRESS 8T	✓	✓	—
GYPRESS 10T	✓	✓	✓
GYPRESS 8T PUSH PULL	✓	✓	✓
GYPRESS PREMIUM 10T PUSH PULL	✓	✓	✓
GYPRESS 10T PUSH PULL	✓	✓	✓
GYPRESS 10T CONNECT	✓	✓	✓



KIT HR210 + HR310 8T PP/10T/10T PP 064089

included XT31-78 (78 mm) 058637

XT31-40 Rallonges bras HR310 pour point milieu - HR310 arm extension for middle point

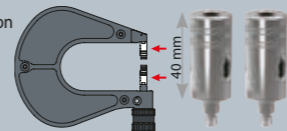

Compatible 8T PP/10T/10T PP x2

066335

OPTIONS

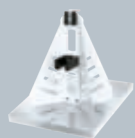

Support Riveteuse pour changements d'accessoires (bras & matrice)
- Riveting machine support for changing accessories (arms & dies)
- Supportständer
↳ 28 x 40 x 21,5 cm

054158



Chariot-Trolley
↳ 79 x 81 x 51 cm
↳ 80 x 15 x 123 cm
44 kg

054233

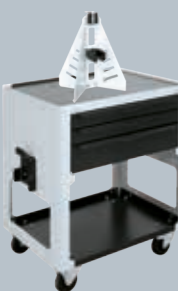

Chariot + Support Trolley + Support
↳ 51 x 122 x 74 cm

055391

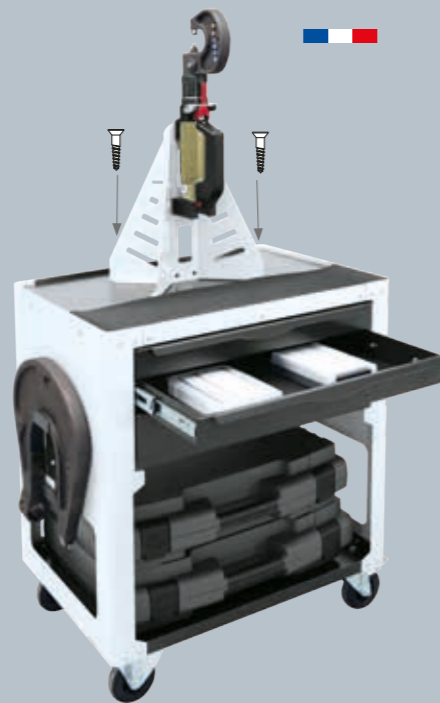

Capteur d'effort 062115

Hydraulic body wrenches (x2) 067325



Serre-tôles - Temporary-fasteners manual mounting

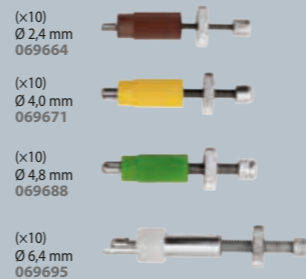

GYPRESS 10T

6.5 bar | 100 kN

10t

063303



US version 070653



Pressure gauge Psi > Kn



Levier de décharge - Discharge lever - Auslösehebel



Contrôle de la vitesse - Speed control - Regelung Werkzeuggeschwindigkeit



Contrôle de la pression - Pressure control - Druckregelung



GYPRESS 10T COMPLETE PACKS

GYPRESS 10T 063303 070653	✓			
GYPRESS 10T pack 1 066441		✓		
GYPRESS 10T pack 2 066458			✓	
GYPRESS 10T pack 3 064744		✓		✓

	AIR BAR	PRESSURE CONTROL	SPEED CONTROL				
MADE IN FRANCE				cm	kg	cm	kg
GYPRESS 10T	6.5 bar = 10 t (maxi 10 bar)	0 > 6.5 bar		39.5 x 180	6.2 (HR110 included)	58 x 48 x 15	11.8



GYPRESS 10T PUSH PULL

6.5 bar 100 kN
10t

063853

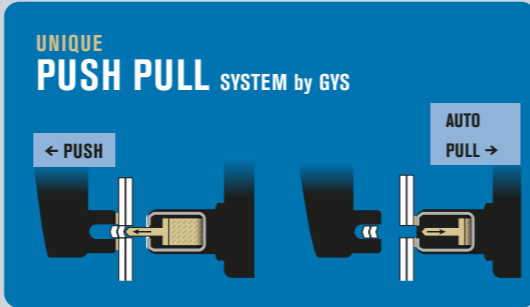
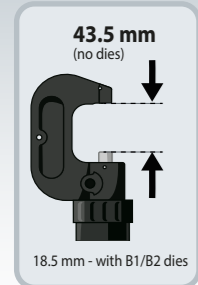

Sélection Push/Pull - Push/Pull selection



Contrôle de la pression - Pressure control - Druckregelung



Contrôle de la vitesse - Speed control - Regelung Werkzeuggeschwindigkeit



GYPRESS 10T PUSH PULL COMPLETE PACKS

GYPRESS 10T PUSH PULL 063853	✓							
GYPRESS 10T PP pack 1 066465		✓						
GYPRESS 10T PP pack 2 066472			✓					
GYPRESS 10T PP pack 3 065789				✓				✓

	AIR BAR	PRESSURE CONTROL	SPEED CONTROL				
				cm	kg	cm	kg
MADE IN FRANCE				39.5 x 180	6.7 (HR110 included)	58 x 48 x 15	12.5
GYPRESS 10T PUSH PULL	6.5 bar = 10 t (maxi 10 bar)	0 > 6.5 bar					

GYPRESS PREMIUM 10T PUSH PULL

6.5 bar 100 kN
10t

077065

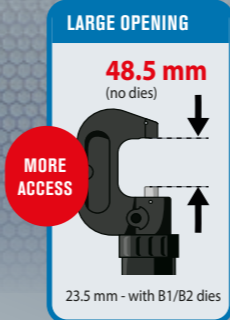

MORE ACCESS

23.5 mm - with B1/B2 dies



US version 070660



Pressure gauge Psi > Kn

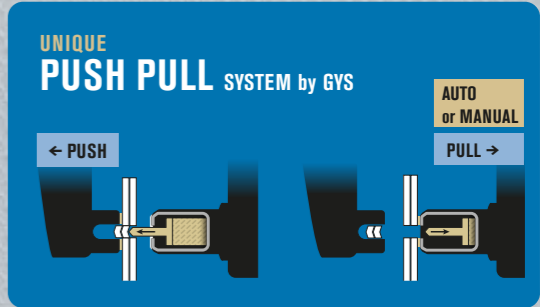

WORK FASTER

ERGONOMIC WITH QUICK SELECTION

Sélection Push/Pull - Push/Pull selection

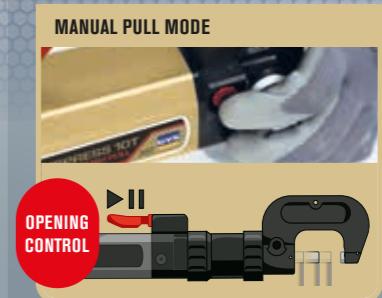

MANUAL PULL MODE

Sélection Manuel/Automatique - Manual/Automatic selection



Contrôle de la pression - Pressure control - Druckregelung



Contrôle de la vitesse - Speed control - Regelung Werkzeuggeschwindigkeit

GYPRESS 10T PREMIUM PUSH PULL COMPLETE PACK

GYPRESS PREMIUM 10T PUSH PULL 077065							
							✓

	AIR BAR	PRESSURE CONTROL	SPEED CONTROL				
				cm	kg	cm	kg
MADE IN FRANCE				39.5 x 180	6.7 (HR110 included)	58 x 48 x 15	?
GYPRESS 10T PREMIUM PUSH PULL	6.5 bar = 10 t (maxi 10 bar)	0 > 6.5 bar					



GYPRESS

SYNERGIC RIVETING WORKSTATION

PNEUMATIC HYDRAULIC



UNIQUE 100%
No air inclusion
maintenance free, no oil refill

ACCESSIBILITY

10 languages

- FR ES CN
- GB CZ JP
- DE NL
- IT RU

★★★★
SYNERGIC RIVETS SETTINGS

Main panel

Setup instructions



Results



3 MODES

- MANUAL
- SYNERGIC
- CAR MANUFACTURERS

CAR MANUFACTURERS COMPATIBILITY

- ✓ VW GROUP
- ✓ MERCEDES-BENZ
- ✓ BMW
- ✓ TESLA
- ✓ FERRARI
- ✓ FORD
- ✓ JAGUAR / LAND ROVER
- ✓ GM

CONNECTIVITY

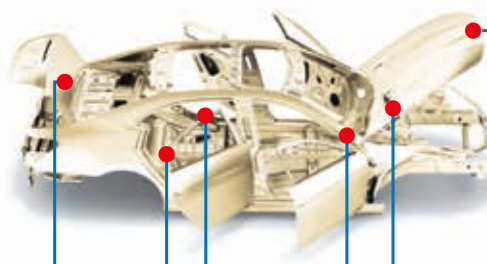

TRACEABILITY

History data export

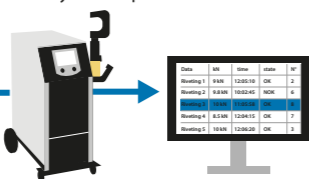

SOFTWARE UPDATE

Gyspress evolutions

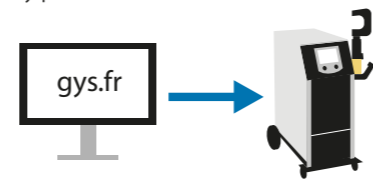

UNIQUE PUSH PULL SYSTEM by GYS

PUSH PULL SYSTEM by GYS

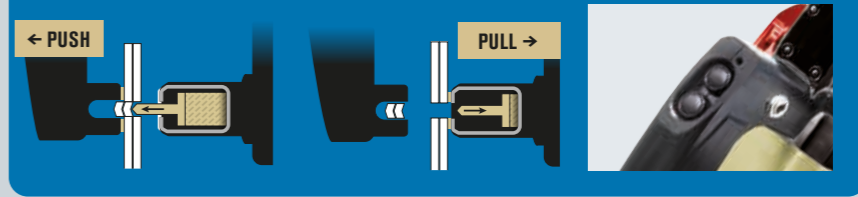

Gyspress support



Arms support



REGULATED PRESSURE CONTROL

POWER 10t



Levier de décharge - Discharge lever - Auslösehebel

WORKSTATION GYPRESS 10T PP CONTROL

6.5 bar 100 kN

10t

063860

included

- HR110 063310
- XT11.21 - Extension for HR110 & HR210 058644
- Standard 10T PushPull tool box 058361
- 6 x 50 rivets RAP - Nieten SPR 048706
- Strap-Sangle-Gurt
- HR arm locker
- Poignée-Handle-Griff

MADE IN FRANCE WORKSTATION GYPRESS 10T PP CONTROL	230V	AIR BAR 6.5 bar = 10t (maxi 10 bar)	PRESSURE CONTROL 0 > 6.5 bar	SPEED CONTROL + -	cm	kg
					74 x 116 x 50	54

OPTIONS

Capteur d'effort 10T PP CONTROL 071759



Youtube

Hydraulic body wrenches for GYPRESS 10T, 10T PushPull, 10T PP CONTROL (x2) 067325

SYNERGIC RIVETING GYPRESS CONTROL



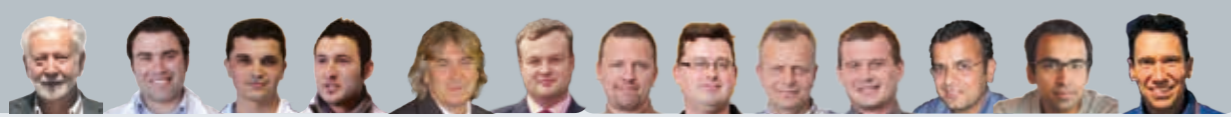

ADAPTATEURS POUR RIVETS AVEUGLES - BLIND RIVET ADAPTERS

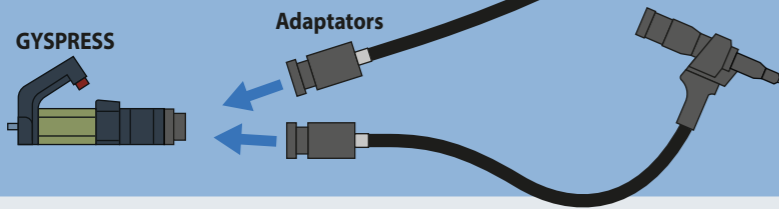

Compatibility
 GYSPRESS 10T
 GYSPRESS 10T PUSH PULL
 GYSPRESS 10T PUSH PULL PREMIUM
 GYSPRESS 10T CONNECT



ADAPTATEUR 24 KN POUR RIVETS AVEUGLES - Blind rivet adapter 24 kN - Blindnietadapter 24 kN

HIGH ACCESSIBILITY



SPECIFIC STORAGE



24 kN STANDARD 600 mm
063822

Pour rivets POP - For BLIND rivets - Für Blindniet
 Acier / Steel: Ø 4.0 → 6.4
 Alu: Ø 4.0 → 7.8



INCLUDED

- 058446 (for standard rivets)
- Ø 3.2 x1 059221
- Ø 3.6 x1 059238
- Ø 4.0 x1 059245
- Ø 4.5 x1 059252

24 kN COMPACT 600 mm
077164

Pour rivets POP - For BLIND rivets - Für Blindniet
 Acier / Steel: Ø 6.4
 Alu: Ø 6.4 → 7.8

COMPACT HEAD

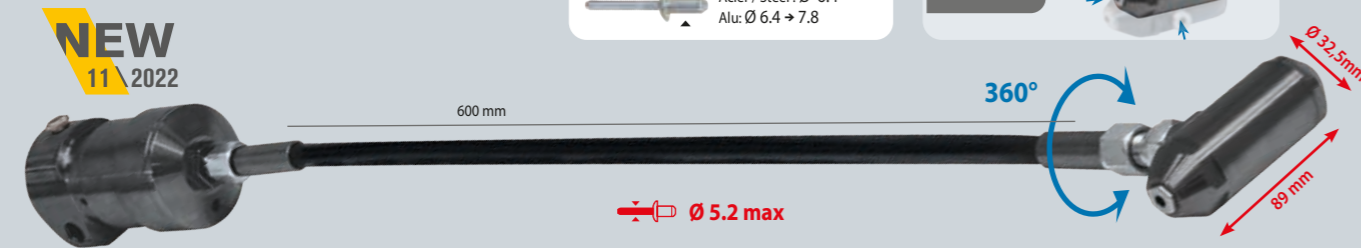

INCLUDED

- 058446 (for standard rivets)
- Ø 4.5 x1 059252
- Ø 5.2 x1 059252

PERFECT COMBO WITH ARC PULL

SPÉCIAL ARRACHAGE DE RIVETS
 Special tearing rivets - Spezial-Zugnieten



OPTION FOR GYSPOT ARC PULL (details p.17)

for GYSPOT ARCPULL 350

ARC PULL RIVET BOX 1 350 - 24kN 064584					
Tige inox - Stainless steel nail Ø 4 x 50 mm 064607	Canon pour pose de tige inox - Barrel for stainless steel nail welding	Support porte-goujon - Mandrel support 059634	Buse + patin - Nozzle + pad 059641	mandrel Ø4mm 049000	Buse d'extraction 24kN Ø 4 064683
x100	x1	x1	x1	x1	x1

ADAPTATEUR 50 KN POUR RIVETS AVEUGLES - Blind rivet adapter 50 kN - Blindnietadapter 50 kN



50 kN 1 m
064867

▲ 4.0 kg

Réglage de la course de traction - Stroke adjustment
 0 → 25 mm

Pour rivets POP - For BLIND rivets - Für Blindniet

Acier / Steel: Ø 4.0 → 6.4
 Alu: Ø 4.0 → 7.8

INCLUDED

Kit Standard



+ Complete kit 065987



OPTIONS

Acier / Steel: Ø 4.0 → 6.4
 Alu: Ø 4.0 → 7.8

Extension 160 mm - 160 mm extension - Verlängerung 160 mm
 066144



Ø 8.0 → 9.8

Kit Rivets Ø8.0/9.8mm - Ø8.0/9.8mm noze-piece kit - Mundstückkit 8,0/9,8 mm
 066045

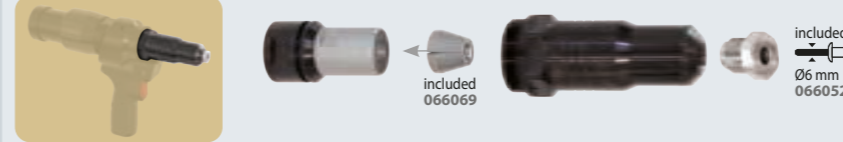

M5 → M14
 M5 → M8

Kit 6 tirants pour pose d'écrous à sertir et goujons à sertir - Blind rivet nut pulling, Blind rivet bolt adapter kit - Blindnietmuttern, Blindnietgewindebolzen-Kit
 066076



	M5	066083
	M6	066090
	M8	066106
	M10	066113
	M12	066120
	M14	066137

OPTION FOR GYSPOT ARC PULL (details p.17)

for GYSPOT ARCPULL 350

ARC PULL RIVET BOX 2 350 - 50kN 073388				
Ø 5 x 50 mm 070745	Canon long + mandrin M5 - Long barrel + mandrel M5 070738	Support porte-goujon - Mandrel support 059634	Buse + pad 059641	Buse d'extraction 50kN Ø 5 066151
x100	x1	x1	x1	x1

for GYSPOT ARCPULL 700

ARC PULL RIVET BOX 700 068452									
Ø 5 x 50 mm 070745	Canon long + mandrin M5 - Long barrel + mandrel M5 070738	Buse d'extraction 50kN Ø 5 066151	Support porte-goujon - Mandrel support 071377	Buse + pad 059641	Ring holder 059610	Fourche pour anneau - Rod for pulling rings 071384	Vis de butée	Ø 6.4	Ø 9.8
x100	x1	x1	x1	x1	x2	x1	x1	x1	x1

BOÎTE CONSOMMABLES POUR ADAPTATEUR 50KN - Consumables box for 50kN adapter - Zubehörbox für 50 kN Adapter



Écrous à sertir - Blind rivet nuts

	M5		M6		M8		M10		M12		M14
0.5 → 3.0	0.5 → 3.0	0.5 → 3.0	0.5 → 3.0	1.0 → 3.5	1.0 → 4.0	4.5 → 6.0					
x50 066175	x50 066182	x50 066199	x50 066205	x50 066212	x10 066229						

+ plaque de démonstration - demo metal sheet

Goujons à sertir - Blind rivet bolts

	M5		M6		M8
22.5 → 27	24 → 28.5	23.5 → 28			
0.5 → 3.0	0.5 → 3.0	0.5 → 3.0			
X50 066236	X50 066243	X50 066250			

+ x10 x10 x10

Rivets aveugles - Blind rivets

	Ø 6.4		Ø 9.8
2.8 → 4.8	3.0 → 14.0		
x50 066267	x50 066274		

+ x10 x10

GMAW MIG/MAG SYNERGIC

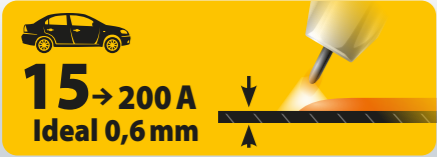

CARMIG
15 → 200 A
400V • 3~
032132
with accessories



M1 GYS AUTO
15 → 160 A Capacitor
230V • 1~
032903
208/240V • 1~
032088
with accessories

Capacitor
M1GYS AUTO, M3GYS AUTO
> PERFECT WELD

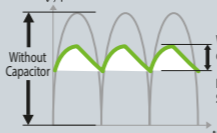

T1 GYS AUTO
15 → 200 A
400V • 3~
032910
T1 GYS AUTO DV
400V • 3~ / 230V • 3~
032927
with accessories



SYNERGIC - EASY TO USE
Réglage automatique de la vitesse / Auto adaptative wire speed
Automatische Einstellung der Drahtgeschwindigkeit

M3 GYS AUTO
15 → 160 A Capacitor
230V • 1~
032880

T3 GYS AUTO
15 → 200 A
400V • 3~
032958

T3 GYS AUTO DV
400V • 3~ / 230V • 3~
032972

with accessories:

Steel 150 A, 3 m, air Ø 0,8 063754
Steel 150 A, 3 m, air Ø 1,0 072121

For T3 GYS AUTO only
with accessories:

032941

câble secteur - mains cable
6m

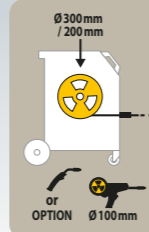

2 x 4 m³ (20L)

2 x 4

100% READY

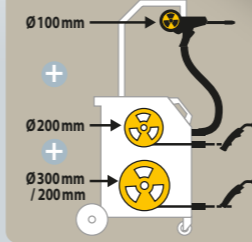

Protection gas
Argon+CO₂ (Steel, Inox)
Argon (ALU/CuSi3/CuAl8)
CO₂PUR (Steel)

INVERTER SYNERGIC

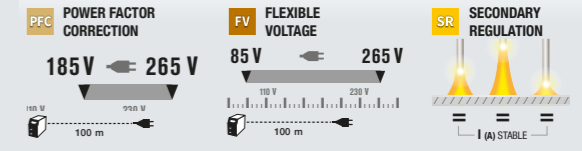

MULTEPEARL AUTO
200 A
P400 PFC FV SR GAS NO GAS MMA TIG
075412
3 m, 2.5 m, 16 mm², 2 m, 16 mm²



SPECIFIC SYNERGIES FOR CAR BODY

Torche motorisée Spool Gun - Spool Gun Torch - Spool Gun Brenner



041486
Ideal for
- Acier / Steel / Stahl
- Inox / Stainless steel
- Alu

included 045699

SPOOL GUN + Support for M3 & T3 GYS AUTO
038554



15L/min (FR) 041998
OPTIMAPRO 30L/min (FR) 043619
30L/min (FR) 041622
(UK) 040274 (UK) 041646
(NL) 040267 (DE) 041219
(IT) 038691 (DE) 041215 (NL) 041615
(IT) 038707

MB 15 (150A)
041226
x3 x5 x3
x5 (M6-Ø0,6)
x5 (M6-Ø0,8)
x3 (Alu-M6-Ø0,8)

041332
T3GYS & M3GYS:
Housse de protection - Protection cover - Schutzhaube
052260



MADE IN FRANCE	MADE IN CHINA	CE NORM. 60974/1	50/60 Hz	A	min → max	Reg	100 (spoolgun) 200 300	Electronic Control	EN60974-1 (40°C)			Equipment d'origine Original equipment Originalausstattung Equipamiento de fabrica	cm/kg	Protected & compatible power generator (+/-15%)	
									IA (60%)	X% (I2 max)	Ø mm				
			400V 3~	10	15 → 200	7		electronic	110	150A@25%	0,6+1	0,6/0,8	0,8	47x77x79 / 50	5 kVA
			230V 1~ 208/240V 1~	16	15 → 160	6	option		90	140A@15%	0,6+1	0,6/0,8	0,8	47x77x79 / 46	4,5 kVA
			400V 3~	10	15 → 200	7	option		110	150A@25%	0,6+1	0,6/0,8	0,8	47x77x79 / 52	5,2 kVA
			230V 3~/400V 3~	10	15 → 200	7			90	140A@15%	0,6+1	0,6/0,8 0,8/1,0	2 x 0,8	60x90x90 / 58	4,5 kVA
			400V 3~	10	15 → 200	7			110	150A@25%	0,6+1	0,6/0,8 0,8/1,0	2 x 0,8	60x90x90 / 75	5,2 kVA
			230V 3~/400V 3~	10	15 → 200	7			100	150 A @22%	0,6+1	0,8/1,0	0,8	41x73x77 / 37	7,5 kW
			110V 1~ 230V 1~	32	20 → 150 20 → 200	-			130	200 A @22%					



GYS AUTO

GMAW MIG/MAG INVERTER SYNERGIC

Lastest generation
colour screen 3.5"

NEW

10 languages

- French
- English
- German
- Italian
- Spanish
- Czech
- Dutch
- Russian
- Chinese
- Japanese

EASY



EXPERT

Pre-gas / Creep speed / Hotstart /
Crater filler / Burnback / Post-gas



EASY TO SETUP



MODES

- MANUEL
- SYNERGIC EASY / EXPERT
- 2T
- 4T
- SPOT
- DELAI

FONCTIONS

- TRACEABILITY
- PORTABILITY
- +500 JOBS can be saved

SYNERGIES

- STEEL
- AlSi
- AlMg
- Cu Si 3 / CuAl 8
- CrNi

UPDATES

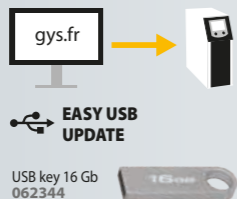

USB key 16 Gb
062344

E1 GYS AUTO

10 200 A 230V 1~ PFC

with accessories :

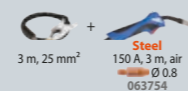

075122

E2 GYS AUTO

10 200 A 230V 1~ PFC

with accessories :



075139

E3 GYS AUTO

10 200 A 230V 1~ PFC

with accessories :



075160

NEW
01 / 2023



10 m³
(50L)
1 x
6 m

E1 GYS AUTO 200 A • × 1



10 → 200 A
Ideal 0,6 mm

PFC POWER FACTOR CORRECTION

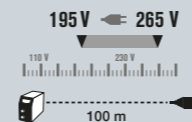

NEW
01 / 2023



2 x 4 m³
(20L)
2 x
6 m

E2 GYS AUTO 200 A • × 2

NEW
01 / 2023



2 x 4 m³
(20L)
3 x
6 m

E3 GYS AUTO 200 A • × 3

MADE IN FRANCE	CE NORM. 60974/1	50/60 Hz	A	6 m	min → max A	Ø mm		Electronic Control	EN60974-1 (40°C)		Equipment d'origine Original equipment Originalausstattung Equipamiento de fabrica	cm	kg	Protected & compatible power generator (+/-15%)
						200	300		IA (60%)	X% (I2 max)				
▪	E1 GYS AUTO	230V 1~	16	6 m	10 → 200	▪	▪		145	20	Acier Type B 0.6/0.8	74 x 49 x 78	43	9KVA
▪	E2 GYS AUTO	230V 1~	16	6 m	10 → 200	▪	▪		145	20	Acier Type B 0.6/0.8 Alu Type B 0.8/1	87.5 x 63 x 90	49	9KVA
▪	E3 GYS AUTO	230V 1~	16	6 m	10 → 200	▪	▪		145	20	Acier Type B 0.6/0.8 Acier Type B 0.8/1 Alu Type B 0.8/1	87.5 x 63 x 90	51	9KVA



77

GYS AUTO

GMAW
FCAW
INVERTER SYNERGIC MIG



GMAW MIG/MAG INVERTER DOUBLE PULSE

Latest generation
colour screen 5"
800 x 480 (WVGA)



ACCESSIBILITY

- 3 interface levels
- 10 languages
- EASY
- EXPERT
- ADVANCED
- French
- English
- German
- Italian
- Spanish
- Czech
- Dutch
- Russian
- Chinese
- Japanese

EASY



3 INTERFACE LEVELS

ADVANCED



EXPERT

Pre-gas / Hot Start / Upslope / Downslope / Crater filler / Post-gas



TRACEABILITY



PORTABILITY



MODES

- DYNAMIC STANDARD
- PULSE
- PULSE IN PULSE
- MANUAL
- COLD PULSE**

FULLY DIGITAL

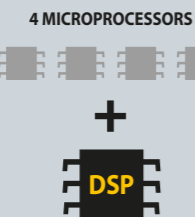

65+ SYNERGIES

Retrouvez toutes les synergies :
Find all the synergies:
Finde alle Synergien :



- STEEL
- Cu Si 3 / Cu Al 8
- ALU

UPDATES

EASY USB UPDATE

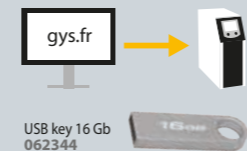

OPTIONS

PUSH PULL TORCH 24 V



MB 15
4m
044111

MB 25
4m
046283

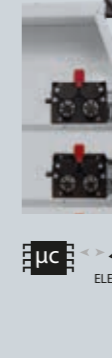

AUTOPULSE 220-M1

1	Ø 200 / 300	PP	
-	-	-	-

AUTOPULSE 220-M2

1	Ø 200 / 300	PP	
2	Ø 200 / 300		

AUTOPULSE 220-M1

15 220 A 230V 1~ PFC

with accessories :

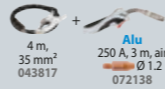

065024

AUTOPULSE 220-M1 208-240V

15 220 A 208>240V 1~ PFC

with accessories :

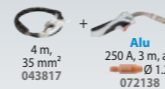

070868



AUTOPULSE 220-M2

15 220 A 230V 1~ PFC

with accessories :

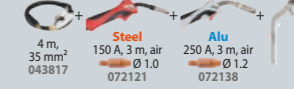

069855

AUTOPULSE 220-M2 208-240V

15 220 A 208>240V 1~ PFC

with accessories :

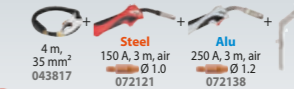

069862



PFC POWER FACTOR CORRECTION

185 V ← 265 V

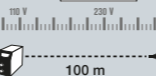

220 A • × 1

220 A • × 2

MADE IN FRANCE EM60974-1	50 / 60 Hz	A	Ø mm	min → max	SPOOLGUN	PUSH/PULL	Ø mm	Cooling system	Equipement d'origine Original equipment Originalausstattung Equipamiento de fabrica	EN60974-1 (40°C)	IA (60%)	X% (12 max)	cm / kg	Protected & compatible power generator (+/-15%)
AUTOPULSE 220-M1	230 V · 1 ~	8 m	16	0.6+1.2	10+220	-	OPTION	Air	ALU : Type B 1.0 / 1.2	150	220 A @ 20%	88x93x63 / 69	10 kVA	
AUTOPULSE 220-M1 208-240V	208 > 240 V · 1 ~	8 m	16	0.6+1.2	10+220	-	OPTION	Air	ALU : Type B 1.0 / 1.2	150	220 A @ 20%	88x93x63 / 69	10 kVA	
AUTOPULSE 220-M2	230 V · 1 ~	8 m	16	0.6+1.2	10+220	-	OPTION	Air	ACIER : Type B 0.8 / 1.0 mm ALU : Type B 1.0 / 1.2	150	220 A @ 20%	88x93x63 / 69	10 kVA	
AUTOPULSE 220-M2 208-240V	208 > 240 V · 1 ~	8 m	16	0.6+1.2	10+220	-	OPTION	Air	ACIER : Type B 0.8 / 1.0 mm ALU : Type B 1.0 / 1.2	150	220 A @ 20%	88x93x63 / 69	10 kVA	

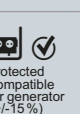



GMAW MIG/MAG

INVERTER DOUBLE PULSE

BODYSHOP SPECIFIC
COLD PULSE
CuSi3 Ø 0.8/1



PFC POWER FACTOR CORRECTION

185 V ← 265 V



AUTOPULSE 220-M3			
1	Ø 200		PP
2	Ø 200		-
3	Ø 200		-

ELECTRONIC

AUTOPULSE 220-M3

15 **220 A** 230V 1~ PFC

with accessories:



036703

AUTOPULSE 220-M3 208-240V

15 **220 A** 208>240V 1~ PFC

with accessories:



062481

OPTIONS

PUSH PULL TORCH 24 V



- MB 15 4m 044111
- MB 25 4m 046283

Motor inside



MB 15 / MB 25 (250 A) 037458

- x5 (Mg-Ø 0.8)
- x5 (Mg-Ø 1.0)
- x5 (Alu - Mg-Ø 0.8)

- x5 (Mg-Ø 0.8)
- x5 (Mg-Ø 1.0)
- x5 (Alu - Mg-Ø 1.0)
- x5 (Alu - Mg-Ø 1.2)

Housse de protection - Protection cover - Schutzhaube 052260

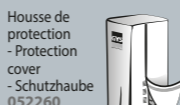

AUTOPULSE 320-T1				AUTOPULSE 320-T3				AUTOPULSE 320-T3 208-240V			
1	Ø 200/300		PP	1	Ø 200		PP	1	Ø 200		PP
2	-	-	-	2	Ø 200			2	Ø 200		-
3	-	-	-	3	Ø 200		-	3	Ø 200		-

ELECTRONIC

AUTOPULSE 320-T1

15 **320 A** 400V 3~

with accessories:

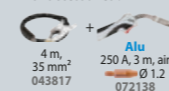

069831

AUTOPULSE 320-T1 208-240V

15 **320 A** 208>240V 3~ PFC

with accessories:

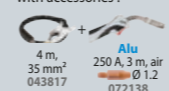

069848

AUTOPULSE 320-T3

15 **320 A** 400V 3~

with accessories:

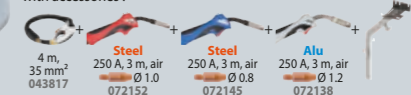

067615

AUTOPULSE 320-T3 208-240V

15 **320 A** 208>240V 3~ PFC

with accessories:



036970



OPTIONS for AUTOPULSE 320-T3 (400V) only

SPOOLGUN TORCH

Ideal Alu

Ø 0,8

4m 041486

Motor inside

220 A • × 3

320 A • × 1

320 A • × 3

MADE IN FRANCE EN60974-1	50 / 60 Hz	A	Ø mm	min → max	SPOOLGUN	PUSH/PULL	200	Cooling system	Equipement d'origine Original equipment Originalausstattung Equipamiento de fabrica		EN60974-1 (40°C)	cm / kg	Protected & compatible power generator (+/-15%)
									ELECTRONIC CONTROL	IA (60%) X% (I2 max)			
AUTOPULSE 220-M3	230 V · 1~	8 m	16	0.6 → 1.2	10 → 220	-	OPTION	Air	ACIER : Type B 0.6 / 0.8 ACIER : Type B 0.8 / 1.0 ALU : Type B 1.0 / 1.2	150 220 A @ 20%	88x93x63 / 69	10 kVA	
AUTOPULSE 220-M3 208-240V	208 > 240 V · 1~	8 m	16	0.6 → 1.2	10 → 220	-	OPTION	Air	ACIER : Type B 0.6 / 0.8 ACIER : Type B 0.8 / 1.0 ALU : Type B 1.0 / 1.2	150 220 A @ 20%	88x93x63 / 69	10 kVA	

MADE IN FRANCE EN60974-1	50 / 60 Hz	A	Ø mm	min → max	SPOOLGUN	PUSH/PULL	200 300	Cooling system	Equipement d'origine Original equipment Originalausstattung Equipamiento de fabrica		EN60974-1 (40°C)	cm / kg	Protected & compatible power generator (+/-15%)
									ELECTRONIC CONTROL	IA (60%) X% (I2 max)			
AUTOPULSE 320-T1	400 V · 3~	5 m	16	0.6 → 1.2	15 → 320	-	OPTION	Air	ALU : Type B 1.0 / 1.2	260 320 A @ 35%	90x92,5x63 / 82.5	16 kVA	
AUTOPULSE 320-T1 208-240V	208 > 240 V · 3~	5 m	25	0.6 → 1.2	15 → 320	-	OPTION	Air	ALU : Type B 1.0 / 1.2	260 320 A @ 35%	90x92,5x63 / 82.5	16 kVA	
AUTOPULSE 320-T3	400 V · 3~	5 m	16	0.6 → 1.2	15 → 320	OPTION	OPTION	Air	ACIER : Type C 0.8 / 1.0 mm ALU : Type C 1.0 / 1.2	260 320 A @ 35%	75x40x94 / 82.5	16 kVA	
AUTOPULSE 320-T3 208-240V	208-240 V · 3~	5 m	25	0.6 → 1.2	15 → 320	-	OPTION	Air	ACIER : Type C 0.8 / 1.0 mm ALU : Type C 1.0 / 1.2	260 320 A @ 35%	75x40x94 / 82.5	16 kVA	

HELMETS

TECHNOLOGY

	Intensity (A)														
	1.5	70	100	125	150	175	200	225	250	300	350	400	450	500	600
MAG	8	9	10				11			12			13		
MIG			9	10			11			12		13	14		
light alloys				10	11		12			13		13			
PLASMA			9	10	11		13								

Teinte initiale - Initial shade



Classic

ULTRA CLEAR

Spectre de couleur - Spectrum view

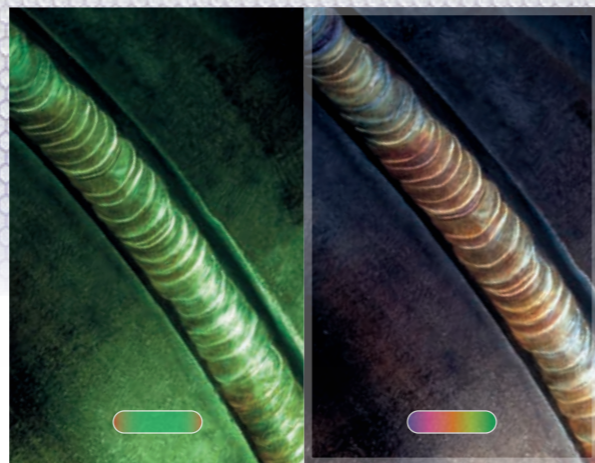

Classic

TRUECOLOR

Capteurs sensibles - Sensitivity sensors

Classic

HIGH SENSIBILITY



Sensors x2

Sensors x4

Sensors x7

Classification - X=/X=/X=/X=

1/1/1/1 = PERFECT QUALITY

(1) Qualité optique (distorsion). (2) Diffusion de la lumière (contraste). (3) Variation de la transmission lumineuse (homogénéités de la teinte foncée). (4) Lumière angulaire (filtre de rayons lumineux diagonaux).

(1) Optical quality (distortion). (2) Light diffusion (contrast). (3) Variation of light transmission (homogeneities of the dark shade). (4) Angular light (diagonal light ray filter).

(1) / (2) / (3) / (4)

Serre-tête - Headgear



Simple

Multi

MULTI PRO

MULTI PREMIUM

Comfortable back

MULTI PREMIUM PRO

Comfortable back / Perfect stability

HELMETS

9-13



LCD FIREMAN 9-13
TRUECOLOR
062269

◀ 100 x 49 mm | □ → ■ 0.1 ms

GRIND TRUECOLOR

IDEAL



LCD GYSMATIC 9/13 G
TRUECOLOR
043909

◀ 100 x 60 mm | □ → ■ 0.08 ms

GRIND + (100) x 4 TRUECOLOR

HELMETS

5-9/9-13



ZEUS 5-9/9-13 G
INDIAN
038332

◀ 100 x 67 mm

□ → ■ 0.1 ms

GRIND + (100) x 4 TRUECOLOR



ZEUS 5-9/9-13 G
FIRE
044098



ZEUS 5-9/9-13 G
COSMIC
044104

OPTIONS



Sac pour masque de soudage - Carry bag for helmet welding
043299



066656



Bandeau anti-transpiration - Antiperspirant - headband
043466 for Multi Premium, Multi Premium Pro, Multi, Simple
062627 for Multi Pro
070844 for Gysmatic 9/13 Air, Gysmatic 5/13 Air XXL



Loupe - Magnifying glass for Zeus, Ergotech & Alien True Color
x1 042780
zoom x2 042780
zoom x3 064140

VERRES - Lenses - Schutzgläser	Dimensions	Weight	Model	TRUECOLOR	HF	DELAY	Classification	Sensitivity	XL	Magnifying Glass	Weight	Brand
226 x 106 (x5)	045781	103.6 x 54 (x5)	040809	LCD FIREMAN 9-13 TRUECOLOR	4-9>13	0.10 ms	—	0.15 > 0.8 s	1/1/1/2	2	100x49 mm	Multi Premium 490 g Gys
114x133 (x10)	043893	G: 106 x 66 (x10)	043886	LCD GYSMATIC 9/13 G TRUECOLOR	4-9>13	0.08 ms	✓	0.10 > 0.90 s	1/1/1/2	4 HIGH SENSIBILITY	XL: 100x60 mm	Simple 580 g Gys
114 x 133 (x10)	043893	103.7 x 69.5 (x5)	043695	ZEUS	4-5>9 / 9>13	0.10 ms	—	0.15 > 0.8 s	1/1/1/2	4	XL: 100x67 mm	Multi 520 g Gys

HELMETS VENTILATED

IDEAL

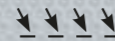

DIGITAL MEMORY & REGULATIONS ELECTRONIC



LCD GYSMATIC 9/13 G AIR TRUECOLOR
065727
069602

100 x 60 mm

0.08 ms



included with LCD GYSMATIC 9/13 G TRUECOLOR

GYSMATIC 5/13 AIR XXL TRUECOLOR
047846
028852

100 x 83 mm

0.1 ms

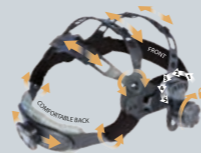

Multi Pro

Filtration class EN 12941: TH2 P R SL Air 165 / 200 220 L/min Battery included

OPTION Filter TH3 065734



Battery charger 037472 028869



Battery included 037465



038424 x1



038417 x5

VERRES - Lenses - Schutzgläser

VERRES - Lenses - Schutzgläser	TRUECOLOR	HF	DELAY	CLASS	SENSITIVITY	SIZE	FEATURES	WEIGHT	BRAND
114 x 133 043893 (x10) G: 106 x 66 043886 (x10)	■	✓	0.10 > 0.90 s	1/1/1/2	4 HIGH SENSITIVITY	XL: 100x60 mm	Simple	580 g	Gys
114 x 133 043893 (x10) 106 x 89,5 (x10) 046825	■	✓	0.1 > 0.9 s	1/1/1/1	4 HIGH SENSITIVITY	XXL: 100x83 mm	Multi Pro	680 g	Gys

ASPIRATEURS DE FUMÉE - Fume Extraction Systems - Rauchgasabsauggerät

UNI 2.0 RE

- 400V 3 ~
- 50 Hz
- 1100 W
- 1500 m³/h max

- arm 3 m
- no plug
- 100 kg
- extraction 0.5 m/s

061545



EVO 2.1 RE

- 230V 1 ~
- 50 Hz
- 1100 W
- 1200 m³/h max
- occasional

- arm 3 m
- included
- 85 kg

061552



EVO 2.2

- 230V 1 ~
- 50 Hz
- 1100 W
- 1100 m³/h max
- occasional

- arm 3 m
- included
- 85 kg

073814



Included
Pré filtre, treillis Aluminium
Class of filtration G3 EN 779
+ Filtre - Coal Filter EPA E12 EN 779, Filtration >99.5 %
046467

Options
Filtre à charbon actif - Coal filter
Ø UNI 2.0 RE
064522

Extraction flexible
10 m, Ø 152 mm
Ø UNI 2.0 RE
Ø EVO 2.1 RE
062139

Included
Pré filtre, treillis Aluminium
Class of filtration F15 G2 EN 779
+ Filtre - Coal Filter HEPA H13 EN 779, Filtration >99.95%
046498

Included
Pré filtre, treillis Aluminium
Class of filtration F15 G2 EN 779
+ Filtre - Coal Filter HEPA H13 EN 779, Filtration >99.95%
075177

TORCHES ASPIRANTES - Fume Extraction Torches - Rauchgas-Absaugbrenner - Antorcha con aspiración de humos

Pour torches aspirantes - for fume Extraction Torches

NEW



BINZEL
073715

- 230V / 1 ~, 1100 W
- 230 m³/h max
- 190 mbar max
- 25 kg, 590 x 425 x 825 mm
- 76 db
- Système de nettoyage automatique du filtre - Filter auto cleaning system - Automatische Filterabreinigung

Filtre Classe M, EN 60335-2-69



included: 5 m, Ø50

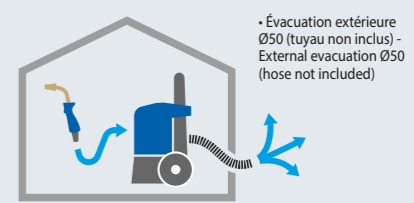

• Évacuation extérieure Ø50 (tuyau non inclus) - External evacuation Ø50 (hose not included)



	Acier/Inox - Steel/Stainless steel - Stahl/Edelstahl			
AIR	150 A	250 A	350 A	500 A
original equipment	M6	M6	M8	M8
Ø	Ø0.8	Ø1.0	Ø1.2	Ø1.2
X % 40°C - ArCO ₂	150A - 60%	200A - 60%	290A - 60%	380A - 100%
GRIP	GRIP	GRIP	GRIP	GRIP
L	3m	3m	4m	4m
Ref.	043251	040540	040557	040564



INDUCTION HEATING

CAR BODY

PFC POWER FACTOR CORRECTION

185 V ← 265 V

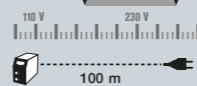

Youtube



PACKS - GYSDUCTION AUTO

	PROLINER AUTO 048775	COMPLETE AUTO 053380	COMPLETE AUTO+ 056978	MECA AUTO 048812	MECA AUTO+ 056961	BODY SHOP AUTO 048799	GLASS AUTO 048805	DENT REPAIR AUTO 054981
1 box	=	=	=	=	=	=	=	=
GYSDUCTION AUTO	✓	✓	✓	✓	✓	✓	✓	✓
Plastic wedges 051294	✓	✓	✓	-	-	✓	✓	-
Burn off Inductor 053373	✓	✓	✓	-	-	✓	✓	-
Body Inductor 053359	✓	✓	✓	-	-	✓	-	-
Bolt Inductor 053366	✓	✓	✓	✓	✓	-	-	-
Remote control 055490	✓	✓	✓	✓	✓	✓	-	-
Universal 800 051331	✓	-	-	-	-	-	-	-
Cable support 052284	✓	-	-	-	-	-	-	-
Dent pulling Inductor 054776	-	-	-	-	-	✓	-	✓
Spiral inductor 054783	-	✓	-	-	✓	-	-	-



055490

GYSDUCTION AUTO

2 400 W 230 V • 1 ~

PFC AIR

CONSUMABLES



Protection (x5)
+ Colle - Stick
053854



Protection (x1)
+ Colle - Stick
059108



Protection (x10)
+ Colle - Stick
053847

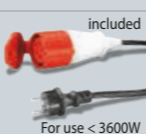

For use < 3600W

included C20/B1
056862

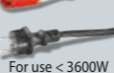

For use < 3600W

For use < 3600W

For use < 3600W

For use < 3600W

For use < 3600W

For use < 3600W

For use < 3600W

For use < 3600W

For use < 3600W

For use < 3600W

For use < 3600W

For use < 3600W

For use < 3600W

For use < 3600W

For use < 3600W

For use < 3600W

For use < 3600W

For use < 3600W

For use < 3600W

For use < 3600W

For use < 3600W

For use < 3600W

For use < 3600W

For use < 3600W

For use < 3600W

For use < 3600W

For use < 3600W

For use < 3600W

For use < 3600W

For use < 3600W

For use < 3600W

For use < 3600W

For use < 3600W

For use < 3600W

For use < 3600W

For use < 3600W

For use < 3600W

For use < 3600W

For use < 3600W

For use < 3600W

For use < 3600W

For use < 3600W

For use < 3600W

For use < 3600W

For use < 3600W

For use < 3600W

For use < 3600W

For use < 3600W

For use < 3600W

For use < 3600W

For use < 3600W

For use < 3600W

For use < 3600W

For use < 3600W

For use < 3600W

For use < 3600W

For use < 3600W

For use < 3600W

For use < 3600W

For use < 3600W

For use < 3600W

For use < 3600W

For use < 3600W

For use < 3600W

For use < 3600W

For use < 3600W

For use < 3600W

For use < 3600W

For use < 3600W

For use < 3600W

For use < 3600W



COMBIDUCTION AUTO 50LG

5 200 W 230 V • 1 ~

PFC LIQUID

065901



INCLUDED COMBIDUCTION

Décapage
Glass
Entfernen
053373



Décollage
Decal
Entkleben
053359



OPTIONS

Inducteur spirale
- Spiral inductor
- Spiralinduktor
054783



Débosselage sans peinture
- PDR : Paintless Dent Repair
- Lackschadenfreies Ausbeulen
054776

Licensed by
BETAG innovation



Spray
refroidisseur
- Freezer spray



Adhesive for logo
(x10)
051492



EN-60 335/1	MADE IN FRANCE	Cable L (m)	Inductor	Heating	cm	kg	Protected & compatible power generator (+/-15%)						
								A	W	kHz	PFC	Liquid Cooling	M10 → 1 s
GYSDUCTION AUTO	230 V, 1~, 50/60 Hz	16 mini	2400	35+100	■	2	2.5	M10 → 1 s	2 mm → 5 s	Ø8 → 10 s	36 x 27 x 22	7.5	3 kW
COMBIDUCTION AUTO 50LG	230 V, 1~, 50/60 Hz	25 mini	5200	20+80	■ 71	8	3	M14 → 1 s	2 mm → 3 s 4 mm → 5 s	Ø10 → 10 s	59 x 88 x 59	72	6 kW



t° POWER HEAT CONTROLLER

t° CONTROL
80>350°C (210>660°F)

5,5m

POWER HEAT CONTROLLER
061644



<p>POWERDUCTION 160LG</p> <p>16 000 W 400V • 3~</p> <p>* LIQUID</p> <p>057814</p>	<p>POWERDUCTION 160LG 208-240 V</p> <p>16 000 W 208-240V • 3~</p> <p>* LIQUID 🇯🇵 🇺🇸 🇧🇷 🇮🇹</p> <p>065253</p>	<p>POWERDUCTION 220LG</p> <p>22 000 W 400V • 3~</p> <p>* LIQUID</p> <p>066861 with 10 m cable : 074576</p>
---	--	---

MADE IN FRANCE	Cable L (m)	Freq.	Liquid Cooling	Inductor	Heating	cm	kg	Protected & compatible power generator (+/-15%)	AM	
									A	W
POWERDUCTION 160LG 400V	6	50/60 Hz	301	M20 → 1 s	2 mm → 2 s 4 mm → 4 s	70 x 118 x 60	136	22 kW	32 mini	16 000
POWERDUCTION 160LG 208-240V	6	50/60 Hz	301	M20 → 1 s	2 mm → 2 s 4 mm → 4 s	70 x 118 x 60	146	22 kW	45 mini	16 000
POWERDUCTION 220LG	6	50/60 Hz	301	M45 → 3 s	8 mm → 9 s 4 mm → 3 s	70 x 118 x 60	141	22 kW	32 mini	22 000
POWERDUCTION 220LG	10	50/60 Hz	301	M45 → 3 s	8 mm → 9 s 4 mm → 3 s	70 x 118 x 60	145	22 kW	32 mini	22 000

OPTIONS

Poignée de lance - Removable handle - Abnehmbarer Griff for POWERDUCTION 160 - 220 LG 068599

Housse de protection - Protection cover - Schutzhaube for POWERDUCTION 160 - 220 LG 050853

Cooling liquid for POWERDUCTION 160 - 220 LG

5L 062511

10L 052246

INDUCTEURS - Inductors

SMALL (Ø16)

* = original equipment	S90 058927	S70 061569	S180 059269	S20/B1 (20°) 064874	S180/B1 064881	S180/B2 064881	S180/B3W 067899	S180/D20 069985	S180/D25 069992	S180/D30 070592	S180/D35 070608	S180/D40 070615	S180/D45 070622	S180/D50 070639	S180/D55 070646
37 LG	✓*		✓					✓							
39 & 50 LG									✓ with adapter 28S						
110 & 160 LG									✓ with adapter 32S						
220 LG									✓ with adapter 32S						

LARGE (Ø32)

* = original equipment	L90 (90°) 059788	L70 (70°) 059771	L180 059795	L180/Spiral 065000	L20/B4 067882	L20 Alu Glove 069114	L180/D60 069923	L180/D70 069930	L180/D80 069121	L180/D90 069947	L180/D100 069954	L180/D110 069961	L180/D120 069978
37 LG													
39 & 50 LG					✓ with adapter 28L					✓ with adapter 28L			
110 & 160 LG	✓* with adapter 32L*				✓ with adapter 32L					✓ with adapter 32L			
220 LG			✓ with adapter 32L		✓ with adapter 32L*					✓ with adapter 32L			

LARGE (Ø32)

* = original equipment	L90 BRAZ 16 Ø 1/2" / 16 mm 076907	L90 BRAZ 28 Ø 1" / 28 mm 076921	L180 BRAZ 16 Ø 1/2" / 16 mm 076914	L180 BRAZ 28 Ø 1" / 28 mm 076938
110 & 160 LG			✓ with adapter 32L	
220 LG			✓ with adapter 32L	

ADAPTER

	28S M28 Ø16 064485	32S M32 Ø16 064508	28L M28 Ø32 064492	32L M32 Ø32 064515
37 LG				
39 & 50 LG	✓		✓	
110 & 160 LG		✓		✓
220 LG		✓		✓

COMPLETE (Ø28)

* = original equipment	C20/B1 (20°) 056862	C180/B1 (90°) 056879	C180/B2 (90°) 056886
39 & 50 LG	✓*		✓

BOÎTES - Boxes

<p>28S/B type W for 39LG & 50LG 072497</p> <p>included : S20/B1 (x1) S180/B1 (x1) S180/B3 (x1) 28S (x1) B1 (x1) B3 (x1)</p>	<p>32S/B type W for 110LG & 160LG 072503</p> <p>included : S20/B1 (x1) S180/B1 (x1) S180/B3 (x1) 32S (x1) B1 (x1) B3 (x1)</p>	<p>L box 065796</p> <p>included : L70 (x1) L180 (x1)</p>
---	---	--

FERRITES - Ferrites - Ferritaufsatz

B1 053823	B2 053458	B3 067875	B4 053755	Spiral 069701
-----------	-----------	-----------	-----------	---------------

Glue kit for inductor
Kit de colle pour inducteur 075948

Colle-Stick bi-composants Power Epoxy 150°C 054851



CUTTER

PLASMA

1~

COMPRESSOR COMPRESSOR INSIDE

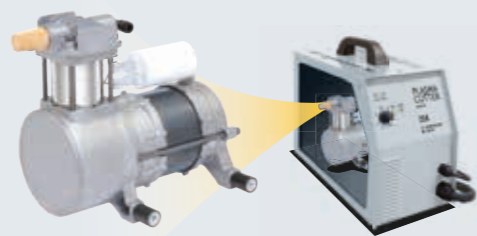

AD ANTI-DUST VENTILATION CORRIDOR

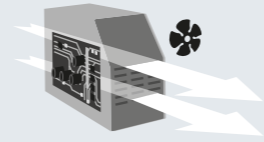

PFC POWER FACTOR CORRECTION

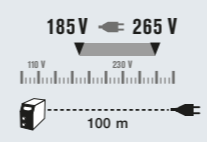

FV FLEXIBLE VOLTAGE

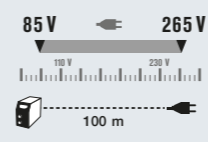

CNC COMPUTER NUMERICAL CONTROL

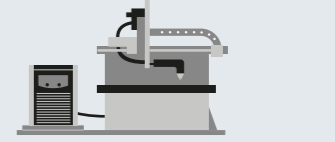

AIR FILTER

PFC EN 61000-3-12 POWER FACTOR CORRECTION

NEW NAME



DIGITAL (PRESSURE SENSOR)



INCLUDED: 8mm



IDEAL CARBONY REPAIR

PFC EN 61000-3-12 FV FLEXIBLE VOLTAGE



DIGITAL (PRESSURE SENSOR)



INCLUDED: 8mm

DIGITAL (PRESSURE SENSOR)

COMPRESSOR Compressor inside

EASycut K25

230 V • 1 ~
25 A Fe 8 mm
Al/CrNi 6 mm

P400 COMPRESSOR

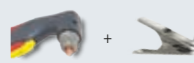

TPT 25, 4 m 2 m, 10 mm²
068063

EASycut K35F

230 V • 1 ~
35 A Fe 15 mm
Al/CrNi 10 mm

P400 PFC AD COMPRESSOR

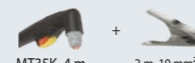

MT35K, 4 m 2 m, 10 mm²
031036

EASycut 25

230 V • 1 ~
25 A Fe 8 mm
Al/CrNi 6 mm



TPT 25, 4 m 2 m, 10 mm²
065543

CUTTER 30FV

110 → 230 V • 1 ~
30 A Fe 15 mm
Al/CrNi 10 mm

P400 PFC FV

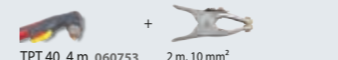

TPT 40, 4 m 060753 2 m, 10 mm²
013858

EASycut 40

230 V • 1 ~
40 A Fe 18 mm
Al/CrNi 15 mm

P400 PFC FV

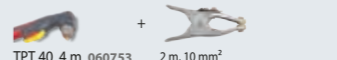

TPT 40, 4 m 060753 2 m, 10 mm²
029743

CUTTER 45 CT

110 → 230 V • 1 ~
45 A Fe 30 mm
Al/CrNi 20 mm

P400 PFC FV GRID CUT AD IP 23 CNC ANALOGIC



TPT 40, 4 m 014787 2 m, 10 mm²
013629

MT 70, 6 m 2 m, 10 mm²
062962

OPTIONS

COMPAS for TPT 40, TPT 25, MT 25K / MT 35K

x1 040199



040205 R max = 670 mm

Consumables

	MT25K	TPT25	MT35K	TPT40
	x4 040182	x4 040236	x4 040229	x4 040236
	x10 040151	x10 040212	x10 040212	x10 040212
	x2 040175	x2 040175	x2 040175	x2 040175
	x10 040168	x10 040168	x10 040168	x10 040168

Coffret - Box 039971

Chariot - Trolley



PLASMA 600
39 x 62 x 58 cm
30 x 11 x 63 cm
040298

Universal 800
48 x 81 x 62 cm
52 x 15 x 81 cm
18 kg
051331

Jobsite XL
60 x 115 x 59 cm
67 x 25 x 48 cm
039568

Filtre déshumidificateur spécial Plasma - Compressed air cleaning filter for Plasma Cutter 40 039728



Cartouche pour filtre - Filter cartridge 039735

CE NORME EN60974-1	CUTTER	I ₂	Coupe max Severance cut			Coupe propre Clean cut			Perçage Piercing			INTEGRATED TECHNOLOGY					AIR SYSTEM			EN 60974-1 (40°C)		Protected & compatible power generator (+/-15%)						
			Fe	Al/CrNi	Fe	Al/CrNi	Fe	Al/CrNi	P400	PFC	FV	GRID CUT	AD	IP23	CNC	COMPRESSOR	min	ideal	max	I 60%	% I2 max		100%	cm	kg			
MADE IN FRANCE	EASycut K25 <i>New</i>	230V 1~	13	10+25	8	6	6	4	—	—	—	—	—	—	—	—	—	—	included	15 A	26%	—	43 x 35 x 20	15	4.1 kW	5.9 kVA		
	EASycut K35F	230V 1~	13	10+35	15	10	10	8	—	—	—	—	—	—	—	—	—	—	included	28 A	30%	20 A	62 x 56 x 32	33	8 kW	10 kVA		
MADE IN GYS CHINA	EASycut 25 <i>New</i>	230V 1~	13	10+25	8	6	6	4	—	—	—	—	—	—	—	—	—	—	2.5 bar 4.5 bar 115 L/min	6.5 bar	15 A	30%	10 A	15 x 42 x 30	8	—	—	
	EASycut 40	230V 1~	16	10+40	20	15	15	12	—	—	—	—	—	—	—	—	—	—	2.5 bar 5 bar 115 L/min	9 bar	23 A	30%	20 A	45 x 28 x 20	10.8	6.5 kW	6 kVA	
MADE IN FRANCE	CUTTER 30FV	230V 1~	16	10+30	15	10	10	8	—	—	—	—	—	—	—	—	—	—	5 bar 115 L/min	7 bar	19 A	25%	15 A	—	—	—	—	
		110V 1~	32	10+30	—	—	—	—	—	—	—	—	—	—	—	—	—	—	—	5 bar 115 L/min	7 bar	41 A	50%	32 A	—	—	—	
	CUTTER 45CT	TPT 40	230V 1~	16	15+45	20	15	15	10	8	6	—	—	—	—	—	—	—	—	5 bar 115 L/min	7 bar	21 A	25%	17 A	—	—	—	—
		MT 70	110V 1~	32	15+30	15	10	10	8	—	—	—	—	—	—	—	—	—	—	5 bar 185 L/min	7 bar	41 A	50%	32 A	48 x 37 x 23	15	10.5 kW	8 kVA

CUTTER / EASYCUT PLASMA CUTTING



COFFRET DE DÉCOUPE JOINT DE PARE-BRISE - Professional Box Set for Windscreen Removal
Removal - Frontscheiben-Trennsystem für Akkuschrauberbetrieb

MADE IN HIGH QUALITY GERMANY



057654

included
Axe enrouleur
068100

included
65 m
resistance 170 kg
Ø 0.79 mm
058125

optional
65 m
resistance 190 kg
Ø 0.92 mm
069275



COUPEAU PNEUMATIQUE DE DÉCOUPE PARE-BRISE
- Oscillating Pneumatic Saw for Windscreen Removal
- Druckluft-Trennmesser für Windschutzscheiben

057623



Included
57 mm
057845

90 mm
057852

8 mm
057876

35 mm
057838

U
36 mm
057869

EXTRACTEUR D'ESSUIE-GLACE - Removal tool for windscreen wiper arms - Wischerarm-Abzieher

UNIVERSEL
057630



EXPERT

Accès difficile
- Difficult access
057647



SYSTÈME DE DÉCOUPE PARE-BRISE À CLIQUET
- Windshield Cutting kit - Set zum Lösen von Windschutzscheiben

054738

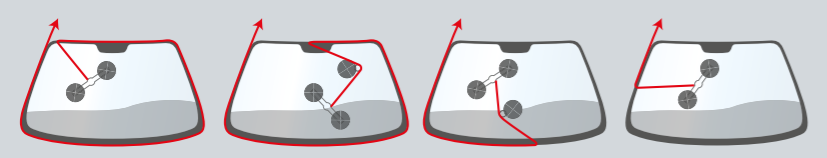

PROTECTIONS TABLEAU DE BORD
- Dashboard Protector - Armaturenbrett Schutz

053120



OUTIL DÉCOUPE PARE-BRISE
- Windshield Cutting Tool - Windschutzscheiben Demontage-Set

051935



KIT DÉCOUPE JOINT DE PARE-BRISE - Windscreen Joint-cutting Kit - Scheibentrenn-Werkzeug-Set

051898



Corde à piano torsadé (22 m)
- Windscreen seal cutting wire (twisted)
- Piano-Schneiddraht, gedreht, 22 m Rolle
051911

Corde à piano carré (50m)
- Windscreen seal cutting wire (square)
- Vierkant-Draht, 50 m Rolle
051881

VENTOUSES - Suction Lifting Pads - Saugnapfwerkzeug für Spiegelgläser

056695



051966



x6
057609

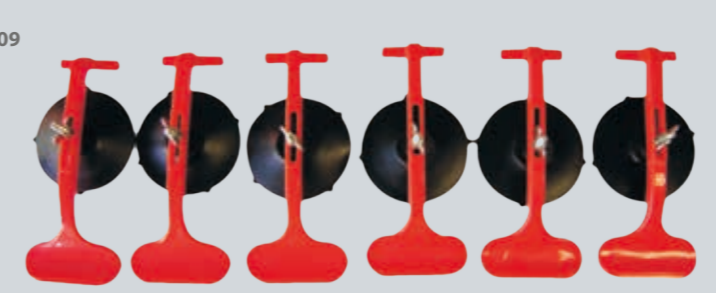

RENOV'POLYCARBONATE - Compressed air polisher - Druckluftpolierer

Complete pack

1 ponceuse orbitale
+ 1 lustreuse
- 1 orbital sander
+ 1 polisher

052086



AGRAFEUSE POUR RÉPARATION PARE-CHOCS - Hot stapler for bumper repair - Stoßstangen Reparatur Kit

052925



INCLUDED:
x20 x20 x20 x20 x20

MADE IN TAIWAN

PORTABLE
Sur batterie - Battery operated
058118

included
Li-ion battery 3.7V
048669
included adapters:
EUR, UK, USA & AUS

Charger included
048652

MADE IN TAIWAN



INCLUDED:
Ø 0.6, x100 Ø 0.8, x100



Agrafes - staples

Angle interne étroit - Inside corner Ø 0.7 mm	Alignement de fissure - Crack alignment Ø 0.7 mm	Fissure importante - Large crack Ø 0.7 mm	Angle interne - Internal angle Ø 0.7 mm	Angle externe - External angle Ø 0.7 mm
x 100 047990	x 100 047983	x 100 047976	x 100 047969	x 100 047952
052413				
=	+	+	+	+
x 50	x 50	x 50	x 50	x 50

COFFRET DE PERÇAGE PARE-CHOCS POUR DÉTECTEURS - Piercing Kit for Bumper Sensors - Lochwerkzeug für Stoßfänger



PRO+
059139
Ø 17-18, 18, 2
19-20-22, 5-24
26-26, 7-32 mm



FREEZER

Spray refroidisseur
- Freezer spray
-50 °C
400 ml
(x 12)
048898



OUTIL DE DÉCLIPSAGE PARE-CHOCS

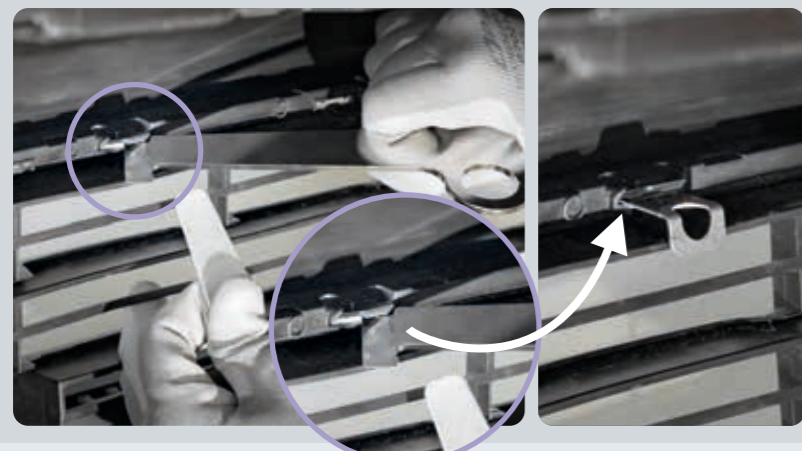

076518
x15
076525

NEW

STATION DE SOUDAGE DES PLASTIQUES - Plastic welding station - Kunststoff-Schweißset



320 W - 230 V, 1-50 Hz
Temperature : 160 < 480°C
▲ 3.4 kg
Length of hose : 1 m
Air flow : 24 l/min

Station seule
- Station only
064072

OPTION

Trolley SPOT 600
053533



Ø 5 mm
066694
Ø 8 mm
066700



baguettes plastique 440 mm	PP / EPDM	▲ 4 mm	x 10	066304
		■ 6 mm	x 10	067622
		■ 8 mm	x 10	066298
ABS		▲ 4 mm	x 10	071322
		■ 8 mm	x 10	071339

Station	PP/EPDM	Pressure wheels	Mini milling machine	Scraper
	4mm (x10)	6mm (x10)	8mm (x10)	
064072	✓			
070974		✓		



Grattoir - Scraper
068032

Roulette de compression
- Pressure wheels
058231

Mini fraiseuse -
Mini milling machine
063228

Tungsten drill
Ø 5 mm
included
063235

KIT DE SOUDAGE DES PLASTIQUES - Welding Kit for Plastics - Kunststoff-Schweißset

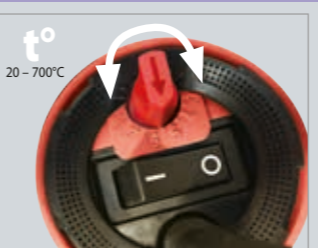

t°
20 - 700°C

1 600 W - 230V - 50/60 Hz
max. 230 l/min
▲ 1.3 kg / ⌀ 100 x 300mm,
poignée Ø 56mm.

057678

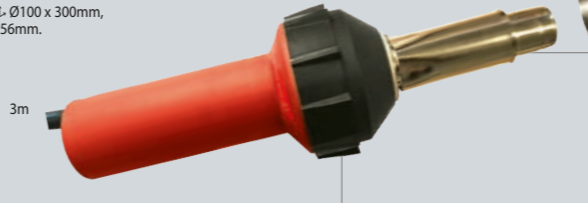

20mm

x10
052956

x1
25 x 12.5 cm
052949



Options

TIP Ø5
061262

TIP insert Ø5
061279

COFFRET DE RÉPARATION DES PLASTIQUES AUTOMOBILES - Brazing automotive plastics repair kit - Kunststoff Reparatur Set

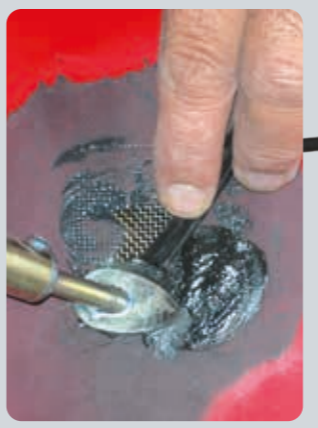

052932

MADE IN BELGIUM



x10
052956

25 x 12.5 cm
x2
052949

057258

052963

GYS HAND TOOLS - Ausbeulwerkzeug

● **FULL PACK = 061637**

MADE IN GERMANY

50 mm
290 mm
15
27,5 mm
50 mm
390 mm
Ø 50 mm

● 053311 ● 053298 ● 061309 ● 053335 ● 053342 ● 053328 ● 053281

MADE IN HIGH QUALITY GERMANY

+ ● **MEDIUM PACK 051133**

● 051430 ● 051416 ● 051454 ● 051447 ● 051409

● 051423

(9 dents/pouce - 9 teeth/inch) 062351

(15 dents/pouce - 15 teeth/inch) 062368

0.70 kg 051485

0.95 kg 051478

1.33 kg 051461

KIT MARTEAUX ET TAS - Planishing Kit for Car Body (Set of 3 Hammers + 4 Dollies) - Karosseriehammer & Handfaust Kit

057579

40 x 40 mm
70 x 90 mm
1.4 kg
061408

117 x 57 mm
1.2 kg
061415

117 x 57 mm
1.2 kg
061422

BURINS - Hand Chisel for Car Body - Meißel für Karosserie

26 x 7 mm
057586

26 mm
230 mm

60 x 11 mm
057593

60 mm
245 mm

COUTEAUX RACLOIRS - Set of 3 scraping knives

061439

15 mm

20 mm

30 mm

LOT DE 3 BURINS DE SÉPARATION ÉLÉMENTS COLLÉS - Set of 3 chisels - 3 Meißel

076754

NEW

250 mm

300 mm

300 mm

PLANISHING HAMMER BLACKTEC®

077270

Manche en caoutchouc - Rubberised gripping

Corrosion resistant

MADE IN GERMANY

OUTILS DE FORME - Forming tools - Formgebungswerkzeuge

051195

180 x 70 x 65 mm

280 x 95 mm

75 x 65 mm

280 x 95 mm

OUTILS DE DÉGARNISSAGE ET RACLAGE - Set of 30 Tools for scraping/sanding and paint removal - Polster & Schaber Kit

057616

JEU DE 4 BURINS EN NYLON - Set of 4 nylon chisels - 4 Kunststoffmeißel

054745

273 mm

19 mm (x1)

22 mm (x1)

25 mm (x1)

38 mm (x1)

JAUGES DE PROFIL - Contour Gauge - Konturenlehre

052840

250 mm

057265

500 mm

JAUGES DE POSITIONNEMENT - Gapping gauges - Spaltmaßlehre

x2 054752

OUTIL DE REMISE EN FORME PASSAGE DE ROUE - Fender roller tool set

060791

REDRESSEUR DE CHARNIÈRE DE PORTE - Fixed Hinge Bending Tool

051102

Redresseur de charnière de porte - Door hinge straightener - Türgelenkausrichter

40 mm max

PINÇES DE MAINTIEN BORD À BORD - Positioning clamp - I-Stoß-Lehre

043190 (x4)

PINÇES MICRO-GRIP - Micro-grip clamps

061330 (x4)

20 mm max

95 mm

PINÇES ÉTAU À BEC PLAT - Flat nose lock-grip pliers

062719

250 mm

100

max 25

75

max 20

200 mm

SERRE-TÔLES - Temporary-fasteners manual mounting

(x10) Ø 2,4 mm 069664

(x10) Ø 4,0 mm 069671

(x10) Ø 4,8 mm 069688

(x10) Ø 6,4 mm 069695

PINÇES AXIALES - Axial-grip pliers

050242

Type I Type J Type JJ Type W Type LL Type G

280 mm 061378 x6

80 mm

610 mm 061354 x2

410 mm

460 mm 061361 x4

240 mm

Flat nose - 610 mm 061347 x2

410 mm

PINÇES ÉTAU MONO SERRAGE - Lock-grip pliers

Flat nose - 460 mm 050112 x6

240 mm

KIT: 050266

x3 x3 x5 x5 = 16

Flat nose 280 mm

MINI-MEULEUSE - Mini disc sander - Druckluftschleifer

051829

Speed adjustment

Ø 75 mm

Speed rpm	Power W	dB	Air consumption l/min	Air pressure bar	cm	kg
18000	200	83	171	6.2	12	0.7

Included (x1) 052468

MEULEUSE D'ANGLE - Long Handled Angle Grinder - Druckluft-Winkelschleifer

057753

Ø 100 mm

± 1.6 mm, x5 057883
± 0.8 mm, x5 058217

Speed rpm	Power W	dB	Air consumption l/min	Air pressure bar	cm	kg
14000	84	113	6.2	37	1.7	

COFFRET DÉCAPEUSE PNEUMATIQUE - Pneumatic surface remover Kit - Druckluftentroster-Box inkl. Zubehör

051775

Speed rpm	Power W	dB	Air consumption l/min	Air pressure bar	cm	kg
4000	500	86	102	6.2	280	1.2

Roue gomme 115 x 14 mm 051874
Roue à décaper 115 x 14 mm 051843
Adaptateur pour brosse 051768

Brosse souple Brins droits 0.5 mm 103 x 23 mm 052598
Brosse dure Brins incurvés 0.7 mm 103 x 23 mm 051812
Brosse souple Brins incurvés 0.5 mm 103 x 23 mm 051850

PINCE À SOYER ET À TROUER, Ø5MM PNEUMATIQUE - Pneumatic flange / ø5 mm punching tool - Pneumatische Loch- und Absatzzange Ø 5 mm

052543

2 in 1

Ø 5 mm

0.8 > 1.2 mm

0.8 > 1.2 mm

058248

x2 Ø

Ø 50 & 75 mm

Speed rpm	Power W	dB	Air consumption l/min	Air pressure bar	cm	kg
15000	84	91	6.2	10	0.6	

MINI-MEULEUSE À RENVOI D'ANGLE - Mini Angle Grinder - Mini-Druckluftwinkelschleifer geräuschgedämpft

051867

Ø 50 mm

90°

Speed rpm	Power W	dB	Air consumption l/min	Air pressure bar	cm	kg
15000	200	86	85	6.2	18	0.75

(x1) 052772

MINI FRAISEUSE - Mini milling machine - Mini-Schleifer

063228

Option Tungsten drill Ø 6 mm 054172

OUTIL DE POINÇONNAGE OBLONGS - Punching tool for oval holes - Langlochkarosserieblechzange

2.2 kg

6 mm 20 mm 052437

8 mm 20 mm 067264

BODY ZIPPER - Sertisseuse pneumatique Pneumatic Crimper - Druckluftkantenformer

056930

MADE IN HIGH QUALITY POLAND

1) MINI
2) initial W
3) final M x < 2.4mm
4) final D x > 2.4mm

Air pressure bar	cm	kg
5	28	2.1

MINI-FLEXIDISC LAMELLES ZIRCON Ø 50 mm

K 40 (x10) 058255
K 60 (x10) 058262
K 80 (x10) 058279

PONCEUSE À BANDE À TÊTE ORIENTABLE - Air belt sander - Druckluft Bandschleifer

060906

520 mm

20

360°

Grain 60 (x5) 060913
Grain 80 (x5) 060920
Grain 100 (x5) 060937
Grain 36 céramique (x5) 062535

Speed rpm	Air consumption l/min	Air pressure bar	cm	kg
16 000	171	6.3	34	1.2

SCIE COUPE TÔLE DROITE ET LIME - Saw for Straight Cut and File - Druckluftsäge und Feile

051805

(x5) 052789

included 058750

Speed rpm	Power W	dB	Air consumption l/min	Air pressure bar	cm	kg
5000	—	85	255	6.2	10	0.8

DÉPOINTEUSE POUR CORDON LASER ACIER - Laser cord metal sheet cutter (nibbler) - Trennwerkzeug für Lasernähte

054165

Ø 6 mm

STEEL Included 054172

DÉPOINTEUSE - Spot remover - Druckluft-Schweißpunktbohrer

SPOT DRILL 050464

360°

Ø 8

Included: Tungsten Carbide Ø 8 for BORON/UHSS (x1)

HIGH QUALITY

Forets de dépointage - Spot remover drill - Schweißpunktfräse Tungsten Carbide for BORON/UHSS

Speed rpm	Power W	dB	Air consumption l/min	Air pressure bar	cm	kg
800	400	85	140	6.5	35	2.3

3-edge Ø 8 mm 053069 Ø 9 mm 069763 Ø 10 mm 053076
4-edge Efficiency ++ Durability ++ Ø 8 mm 059849 Ø 9 mm 069770

Youtube

PONCEUSE À BANDE À TÊTE ORIENTABLE - Air belt sander - Druckluft Bandschleifer

052819

360°

330 mm

10 mm

Grain 80 (x10) 052833
Grain 36 céramique (x20) 062528

Speed rpm	Air consumption l/min	Air pressure bar	cm	kg
16000	171	6.3	26	0.9

MINI-FRAISEUSE À RENVOI D'ANGLE - Mini Angle Milling Machine - Mini-Winkelschleifer

051836

90°

Speed rpm	Power W	dB	Air consumption l/min	Air pressure bar	cm	kg
18000	500	81	85	6.2	18	0.7

PERCEUSE MANDRIN AUTOMATIQUE - Automatic Mandrel Drill - Druckluftbohrmaschine m. Schnellspannfutter

051799

Ø 13

Speed rpm	Power W	dB	Air consumption l/min	Air pressure bar	cm	kg
800	300	92	170	6.2	18	0.9

PACK SPOT DRILL + 140 mm 061460

140 mm 061453

3-edge Ø 8 mm 053069

PISTOLET ANTISTATIQUE
- Antistatic gun - Pistola antistatica - Pistola antiestática

NEW

077010

Position correcte des particules de métal après ionisation
- Correct metal particles positioning, with ionisation
- Posizionamento corretto delle particelle con ionizzazione
- Posicionamiento correcto de las partículas metálicas después de la ionización



included:



charger



support

DÉTECTEUR ÉPAISSEUR DE PEINTURE
- Film coating thickness gauge

059856

Measurement range : 0 - 1.80mm
Resolution : 0.01mm / 1mm
Measurement error : +/- 0.03 mm
Power Supply : 2x 1.5V AAA batteries (included)
Overall dimensions : 62 x 30.5 x 105 mm

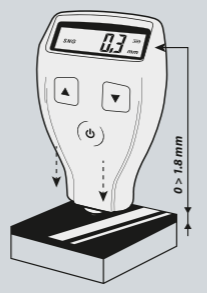

PONÇEUSE / POLISSEUSE ÉLECTRIQUE - Electric Sander & Polisher
- Elektro-Polier-Schleifer

ASPIREUR PNEUMATIQUE POUR POUSSIÈRES ALU (ATEX)
- Pneumatic aluminium dust atex vacuum cleaner

057999

Orbital 5.0 mm
↳ 303 x 101 mm
1.21 kg
Speed : 4000, 7000, 9000 10000 rpm
AC-in 220V - 230V / 50 - 60Hz

((No vibration))

Speed control



Ø 35

Ø 152 mm

Light weight
& Compact

058866

Dust container capacity : 25 l
Working compressed air pressure : 7 bar
Compressed air consumption at 6 bar : 800 l/min
Suction connection diameter size : 50 mm
Max suction capacity : 150 m³/h
Max vacuum level : 2000 mm H₂O
Recommended compressor power : 7.5 HP

↳ 74 x 45 x 45 mm
▲ 18 kg



Manual or automatic

058293

Power supply : 230V / 50Hz
Power : 1400W (max 2000W)
Max. vacuum : 170 mbar
Air flow : 2700 l/min
Drum capacity : 30 L
Drum material : stainless steel
↳ 380 x 380 x 700 mm
▲ 7 kg



4m Input Ø 32 mm Mains cable length 4.5m



included
Filtre - Filter
075405



included
Sac à poussières - Filter bag
Capacity 5 kg
x5
058880



5m Output Ø 29 mm Input Ø 35 mm

GYS DUST EXTRACTOR - Pneumatic dust vacuum cleaner for sander

INNOVATIVE SUCTION SYSTEM

Depression **1150 mm H₂O**
Air flow **600 l/min**
Air consumption **340 l/min**

Pression ponçeuse ajustable - Adjustable sander pressure
5 bar max

↳ 350 x 800 x 400
▲ 21 kg



ATEX norm
Group II - Category 3

- ✓ **ROBUST**
- ✓ **QUICK & SAFE**
- ✓ **LOW AIR CONSUMPTION** (5 bar)
- ✓ **NO ELECTRIC MOTOR**
- ✓ **ENERGY SAVING**

Rangement pour disques de ponçage*
- Sanding discs box*
*disques de ponçage non inclus - discs box not included



Grande maniabilité et stabilité
- High maneuverability and stability

EASY ACCESS

Aucune maintenance
- Maintenance free



Consumables



Sac à poussières - Filter bag
Capacity 5 kg
Included x1
x5
058880



5 m
Ø 29 mm

Option :
10m
Ø 29 mm
076013



Included
Earth clamp
safety



Ponçeuse pneumatique
- Pneumatic Sander
MIRKA PROS 650CV
Ø 150 mm
071346

2 MODELS

GYS DUST EXTRACTOR

MANUAL

Démarrage manuel
- Manual start

071353



GYS DUST SELF EXTRACTOR

AUTOMATIC

Démarrage automatique
- Automatic start

077058



NEW
12 2022

LAMPES BALADEUSES - Hand lamps - Handleuchte

Lampe BALADEUSE TRIPODE 250 L
100-250 lumens (x3)

3 x 1 W COB LED
3 x 3.6 V - 300 mAh
AAA rechargeable, Ni-MH
USB charging (6h)
operating time
High position : 1 h
Low position : 3 h
Flashing : 5 h



Lampe BALADEUSE PRO 600 L
250-600 lumens

COB LED, 80 CRI
3.7 V - 2200 mAh Li-ion
micro USB charging (3.5 h)
operating time
High position : 1.5 h,
Mid position : 4.5 h,
Top light (100 lumens) : 10 h



Lampe BALADEUSE 400 L
400 lumens

COB LED
Li-ion
Charging time : 8h
operating time
High position : 2.5 h
Low position : 1 (1 W) : 6 h

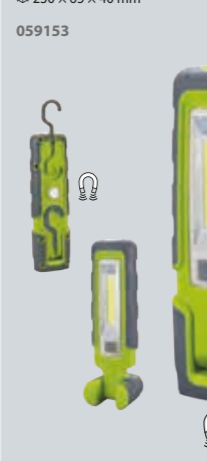

Lampe BALADEUSE ÉTANCHE 400 L
200-400 lumens

COB LED
3.7 V - 2000 mAh Li-ion
USB charging (4/6 h)
mains charger not included
operating time
High position : 2 h
Mid position : 4 h
Top light (4 W) : 3 h



Lampe AMBIANCE 360° PORTABLE 1000 L
60-1000 lumens

>80 CRI SMD LED
6500 K
3.7 V - 5200 mAh Li-ion
USB charging (4.5h)
USB power supply
operating time 2 > 27 h

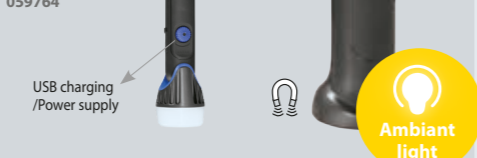

LAMPES D'INSPECTION - Inspection lamps - Inspektionslampen

Lampe INSPECTION FRONTALE 280 L
100-280 lumens

3 W COB LED, 80 CRI+, 6500 K
3.7 V - 1500 mAh Li-po
micro USB charging
mains charger not incl.
operating time
High position : 2 h
Low position : 6 h
IP 65

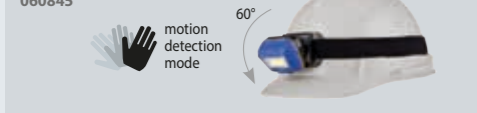

Lampe INSPECTION MINI 200 L
120-200 lumens

COB LED, 80 CRI, 6500 K
3.7 V - 700 mAh Li-ion
micro USB charging (2.5 h)
mains charger not included
operating time
High position : 1.5 h
Low position : 4 h
Top light : 3.5 h
IP 20



Lampe INSPECTION PRO 600 L
0-600 lumens

COB LED
6500 K
3.7 V - 2600 mAh Li-ion
operating time
1.5 > 15 h

057760
058309

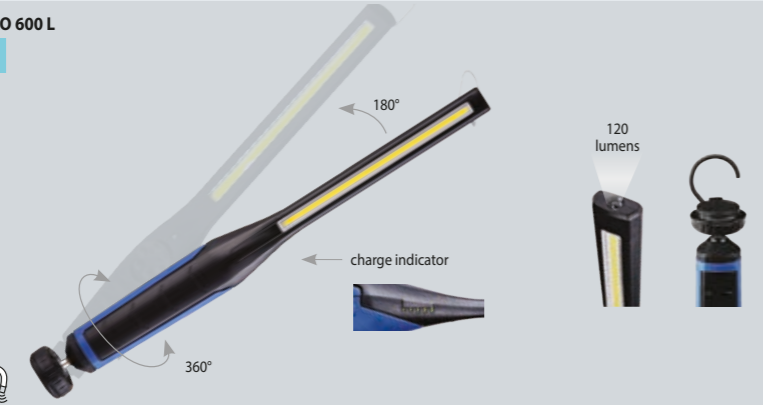

LAMPES SOUS CAPOT - Under bonnet lamps - Leuchte für Motorhaube

Lampe SOUS CAPOT 600 L
500-1000 lumens

120 COB LED
3.7 V - 4000 mAh Li-ion
charging time : 10/12 h

operating time
High position : 4 h
Low position : 8 h



Lampe SOUS CAPOT 800 L
250-800 lumens

120 COB LED
3.7 V - 4000 mAh Li-ion
charging time : 10/12 h

operating time
High position : 3 h
Low position : 6 h

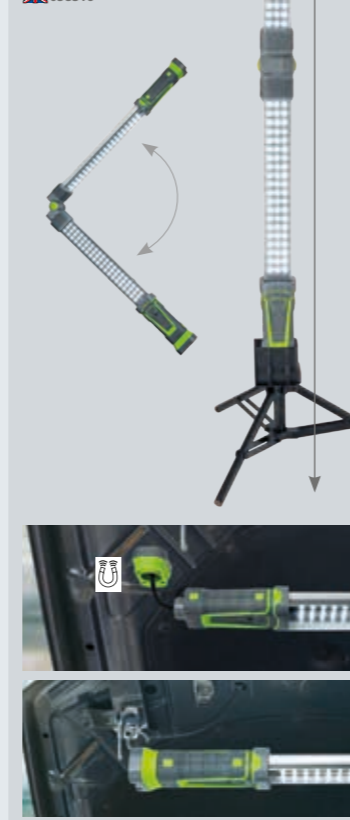

PROJECTEURS LED SUR TRÉPIED - LED worklights with tripod - LED-Arbeitsleuchte mit Standfuß

Lampe sur TRÉPIED 1800 L
1800 lumens

3 x 55 COB LED
total 165 LED
1.8 m power cord
059146



Lampe sur TRÉPIED 3000 L
3000 lumens

35 W COB LED
2 m power cord
IP 44
059979



Lampe sur TRÉPIED 4000 L
4000 lumens

3 x 20 COB LED,
total 60 LED
3 m power cord
059986

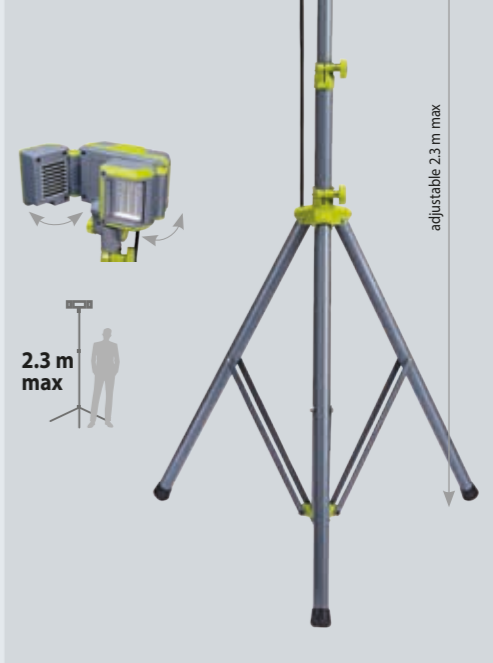

CONTRÔLE DES COULEURS - Detailing & colour match - Fabnpassung & Aufbereitung

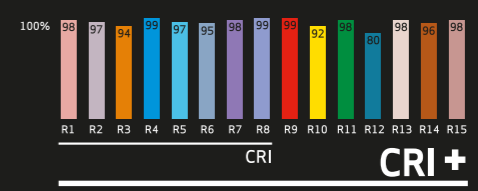

4500 K
400 lumens
SUNCOLOR 1
COB LED, CRI > 95, 1100 lux
3.7 V - 2600 mAh Li-ion
USB charging
operating time : 3 h
190 x 56 x 29 mm
290 g
IP 65



3 COLORS
2700 - 4500 - 6500 K
350-420-450 lumens
SUNCOLOR 3
COB LED, 96 CRI+
3.7 V - 2600 mAh Li-ion
micro USB charging (4 h)
operating time : 2.5/4 h
IP 65
190 x 56 x 29 mm, 290 g
060838



5 COLORS
2700 - 3500 - 4500 - 5500 - 6500 K
500-1000-2000 lumens
SUNCOLOR 5
COB LED, 96 CRI+
11.1 V - 4400 mAh Li-ion
charger 110/240 V, 5 m cable, 15 V, 1.5 A
charging time : 3.5 h
operating time
High position : 2 h, Mid : 4 h, Low : 8 h
IP 65
225 x 200 x 70 mm, 1.2 kg
060876



5 COLORS
2500-3500-4500-5500-6500 K
250-500 lumens
SUNMATCH 3
COB LED, 96 CRI+, 700-1400 lux
3.7 V - 2600 mAh Li-ion, USB charging
operating time :
High position : 2 h, Low position : 4 h
IP 65
204 x 89 x 81 mm, 270 g
061651



SÉCHAGE UV - UV CURING
UV LED λ 395-400 nm

Irradiance 6-15 mW/cm²
NOVA-UV S
3.7 V - 5400 mAh Li-ion
COB charger, 1 m cable, 5 V, 2 A
charging time : 3.5 h
curing area : Ø 20 cm
operating time 1.5 h
IP 67
163 x 63 x 163 mm
061620





TRÉTEAUX - Frames support - Klappböcke

040601
100.5 x 112 cm - 5.5 kg
35 x 95 x 106 cm

Ø28 mm

4 pieds coudés
Idéal sur caillébotis
- Bent feet for grating
- Abgewinkelte Standfüße:
Sicherer Stand auf Gittern u.ä.

Chainette réglable
- Adjustable catenary

Mousse de protection
- Protecting foam

Antidérapants
- Non-slip base

040311
104.5 x 117 cm - 8.1 kg
32 x 10 x 106 cm

Ø32 mm

4 ventouses
Dépose vitrages
- Suction pad for glazing
- Gummiteller zur Fixierung
von Glasscheiben

040250
100 x 105 cm - 7 kg
32 x 10 x 106 cm

Ø32 mm

Léger et très maniable
Spécial travaux à l'horizontal
- Light and easy to handle
Ideal for horizontal works
Speziell geeignet für Arbeiten
in horizontaler Position

040304
104.5 x 108.8 cm - 8.1 kg
32 x 10 x 106 cm

Ø32 mm

20 x 20 mm 16.5 kg

MADE IN HIGH QUALITY POLAND

15 > 125 cm

88 > 128 cm

3 mm

Ø75 mm

Ø250 mm

87 cm

070677

**SUPPORT PARE-CHOCS - Rotary element support
Lackierstände für Stoßstange, einstellbar**

052376
91 x 105 cm - 7.6 kg
60 x 11 x 75 cm

Adapté aux coques de rétroviseurs
- Adapted to wing mirror covers
- Geeignet für Außenspiegel

059825

106 x 104 x 215 cm - 32.5 kg
112 x 31.5 x 21.5 cm
+ 12 x 9.5 x 194.5 cm

50 cm

059832

50 x 150 cm - 13 kg
152 x 15.5 x 11.5 cm

50 cm

**SUPPORT ÉLÉMENT ROTATIF - Rotary element support -
Lackierstände für Stoßstange, einstellbar**

052611
200 x 101 cm - 17.5 kg
35 x 15 x 110 cm
Made in China

PRO 056725
200 x 105 x 81 cm - 22 kg
24 x 17 x 118 cm

1.5 mm

360°

2 mm

Verrouillage de l'axe - Locking of the axis
- Verriegelung der Achse

MADE IN HIGH QUALITY POLAND

**CHARIOT EXTENSIBLE POUR ÉLÉMENTS DE CARROSSERIE -
Extendable support - Ausziehbarer Wagen**

061507
max 150 kg

100 cm

135 - 210 cm

26 kg
114.5 x 42 x 13.5 cm

MADE IN HIGH QUALITY POLAND

**CHARIOT DE LUXE MAROUFLAGE - Premium masking machine -
Abdeckpapier-Ständer**

MADE IN HIGH QUALITY POLAND

x 5 (not included)
rouleaux de papier
- Papierständer
- Paper roll
30 > 120 cm

057333
150 x 133 x 62 cm
32 kg
152 x 17 x 29 cm

OPTION
Ø40 mm
x 6
058897

**CHARIOT DE MAROUFLAGE - Masking machine -
Abdeckpapier-Ständer**

MADE IN HIGH QUALITY POLAND

x 3 (not included)
rouleaux de papier
- Papierständer
- Paper roll
30, 60, 90 cm

056954
150 x 62 x 110 cm
- 12 kg
122 x 29 x 17 cm

**CHARIOT DE STOCKAGE - Storage trolley -
Lagerrollwagen**

040243

71 x 90 x 197 cm
41 kg
x2:
90 x 6 x 147 cm
+ 97 x 74 x 24 cm

TIGES DE BLOCAGE - Flap Lock

056732

30 > 115 cm

**TABOURET - Round Stool with Tool Storage -
Werkstatt-Rollhocker**

057555
38 x 38 x 44 cm - 6 kg
40 x 40 x 18 cm

max: 50 cm
min: 38 cm

SERVANTE 3 PLATEAUX - Workstation 3 shelves

068056

65 kg max

835 mm

65 kg max

65 kg max

390 mm

800 mm

SERVANTE PREMIUM 5 TIROIRS - Workstation Premium 5 drawers

076143

NEW 02/2023

1000 mm

560 mm

940 mm

**CHARIOT DE VISITE - Mechanics Creeper With
Tilting Headrest - Werkstatt-Rollliege**

057548
102 x 43 x 11 cm
7.2 kg
11 x 44 x 13 cm

**MARCHE PIED - Folding Step Stool (Aluminium) -
Arbeitspodest klappbar**

ALU 150 kg

057562
8.2 kg
102 x 41 x 59 cm

960 mm

385 mm

475 mm

**CHARIOT POUR ÉLÉMENTS DE CARROSSERIE -
Universal support - Universelle Ständer**

066281
20 kg

max 80 kg

Ø 4.5 cm

80 cm

Ø 12.5

115 cm

70-100 cm

MADE IN HIGH QUALITY POLAND

ALU 150 kg

058552
15.5 Kg

1090 > 1750 mm

520 > 900 mm

300 mm

116 x 43 x 17 cm - 16.5 kg

COUVERTURE ANTI-CHALEUR - Heat cover - Hitzeschutzdecke - Manta anti-calor - Protecção anti-aquecimento

PROTEC 550
 550°C/1000°F - Class M0
 2m x 2m - 580 g/m²
 050495

PROTEC 1200
 1200°C/2200°F - Class M0
 1.75m x 1.5m - 1200 g/m²
 050204

PROTEC 1300
 1300°C/2400°F - Class M0
 XL: 2m x 1.8m - 620 g/m²
 053595

PROTEC 1300L
 1300°C/2400°F
 XL: 2m x 1.8m - 427 g/m²
 060500

JEU DE 2 AIMANTS

- Set of 2 magnets -
Schweißmagnet

(x2)
052291

COUVERTURE MAGNÉTIQUE - Magnetic cover - Magnetschutzdecke

1.06 m x 0.6 m
061446

RIDEAU DE SOUDAGE - Welding curtain and frame - Schweißerschutzwand

OPTI 215.0
 Orange CE - 2 x 2.15 m
 EN 25980 - 2015/01
 060470

OPTI 200G
 Green T9 - 2 x 2 m
 EN 25980 - 2015/01
 060463

MASQUES RESPIRATOIRES - Respiratory masks - Atemschutzmaske - Máscaras respiratorias

FFP3 - EN 140 / EN 143 / EN 166
 (x1) Size M/L
 037021

FFP3 - EN 140 / EN 143
 (x1) Size M/L
 037014

Étui / Case
037045

FFP3 - EN 143 : 2000 P3
 Anti poussières /
Anti odeurs
037038

LUNETTES DE PROTECTION

- Protection goggles - Schutzbrillen

EN 166

Shade/IR0
042810
 Shade/IR0
042827
 Shade/IR5
042841
 Shade/IR0
047778
 Shade/IR0
047792
 Shade/IR0
042865
 Shade/IR0
047839

GANTS - Gloves - Handschuhe - Guantes

Anti coupe -
Anti-cut
T9
045897
 EN388
4342

✓ écran tactile
- touch screen friendly
 Anti coupe
haute résistance
High resistance anti-cut
EN 420
EN 388:4121
 T9: 045910
 T10: 045927

Anti coupe
haute dextérité
anti-cut
High dexterity
anti-cut
EN 420
EN 388:1121
 T9: 045903
 T10: 045934

T10
064188
 EN420
2003
 Ultra Flexible
EN388
2003

EN388
4244
 EN 407
424X4X
EN12477
Class: A1
 Heavy Duty T10
(MMA - MIG - Plasma)
045101

Cuir
Leather
EN388
2122
 EN 407
322X2X
EN12477
Class: A1
 Gants PRO TIG
T10
045194

Cuir
Leather
EN388
2011XX
 EN 407
41313X
EN12477-B
EN 420
 Gants PRO TIG EXTRA
T10
045323

TABLIER CUIR MULTI-USAGE

- Multi-use leather apron - Delantal de cuero multi-uso - Mehrzweck-Lederschürze

Cuir
Leather
PRO
045217

ÉQUIPEMENTS POUR OPÉRATIONS SUR VÉHICULES ÉLECTRIQUES & HYBRIDES - Equipment for operations on electric and hybrid vehicles - Ausrüstung für den Betrieb von Elektro- und Hybridfahrzeugen

ÉCRAN FACIAL AVEC SERRE-TÊTE
- FACE SHIELD WITH HEADBAND
068018

GANTS ISOLANTS (T10)
- INSULATING GLOVES (T10)
068025

Coffret de 25 outils isolés 1000V
- Box mit 25 isolierten Werkzeugen 1000V
066489

Douilles 7/8/10/12/14/15/17/19/22 mm - 7/8/10/12/14/15/17/19/22 mm sockets	x 9
Pince universelle de 175 mm en chrome vanadium - 175 mm universal pliers in chrome vanadium	x 1
Pince coupante 150 mm en chrome vanadium - Cutting pliers 150 mm in chrome vanadium	x 1
Cluqiet en 3/8" - 3/8" ratchet	x 1
Rallonge 100 mm - Extension 100 mm	x 1
Poignée en T - T-handle	x 1
Clés plates à fourches 7/8/10/12/14/17 mm - Open ended wrenches 7/8/10/12/14/17 mm	x 6
Couteau pour câble - Cable knife	x 1
Tournevis Philips PH1x100/PH2x100 mm - Philips PH1x100/PH2x100 mm screwdriver	x 2
Tournevis plats 5.5x125/4x100 mm - Flat screwdriver 5.5x125 / 4x100 mm	x 2

Kit pour le balisage de la zone d'intervention
- Kit for marking the area of intervention
- Kennzeichnungsset für Hochvolt-Bereiche
064409

Balise de signalisation rouge et blanche - Red and white warning pole	x 4
Chaîne de délimitation rouge et blanche - Red and white bounding line	x 1
Pancarte de signalisation "Danger, zone de travail VEH" - Sign board "Danger, working area EHV"	x 2

PANTALON - Trousers - Hose

EN ISO 11611
Class 2-A1 & A2
 EN ISO 1149-5
 EN ISO 11612
A1+A2-B1-C1-E3-F1
 IEC 61482-2
Class 1-4kA

98% cotton,
2% antistatic
 S (40/42) 046368
 M (44/46) 046375
 L (48/50) 046382
 XL (52/54) 046399
 XXL (56/58) 046412

VESTE - Jacket - Jacke

IEC 61482-2
Class 1-4kA
 EN ISO 11612
A1+A2-B1-C1-E3-F1
 EN ISO 11611
Class 2-A1 & A2
 EN 14404
+A1
Type 2
 EN 1149-5

98% cotton, 2% antistatic
 S (40/42) 046313
 M (44/46) 046320
 L (48/50) 046337
 XL (52/54) 046344
 XXL (56/58) 046351



A COMPLETE RANGE

for 200 > 240 V MONO / TRI
50/60 Hz

DÉBOSSÉLAGE - Dent pulling - デントプラー

- GYSLOT
- 2600
- 2700
- 34.02
- 39.02
- PRO 230
- EXPERT 200
- EXPERT 230
- ALU PRO FV
- COMBI 230 PRO
- ARC PULL 200
- COMBI ARCPULL
- ARCPULL 350



SOUDURE PAR POINT - Spotwelding - スポット溶接

- PTI-s7 220 V
- PTI PREMIUM PRO 220 V
- BP GENIUS 220 V
- PTI GENIUS 220 V



RIVETAGE - Riveting - リベット打ち

- GYSRESS
- 10T
- 10T PP
- 10T PREMIUM PP
- 10T PP CONTROL



MIG/MAG TRADITIONNEL - Traditional MIG/MAG - ミグマガトラディショナル

- M1GYS AUTO
- M3GYS AUTO
- T1GYS AUTO DV
- T3GYS AUTO DV



MIG/MAG INVERTER PULSÉ - ミグマガパルスインバーター

- AUTOPULSE
- 220-M1 (208-240V)
- 220-M2 (208-240V)
- 220-M3 (208-240V)
- 320-T1 (208-240V)
- 320-T3 (208-240V)



CHARGEUR - Battery charger - バッテリーチャージャー

- GYSFLASH
- 103.24 CNT FV
- 50.12 FV
- 53.48 CNT FV
- 51.12 FV
- 128.12 CNT FV
- 121.12 CNT FV
- 125.12 CNT FV
- 101.24 CNT FV
- 51.48 CNT FV
- 123.12 CNT FV



DÉCOUPAGE PLASMA - Plasma cutting - プラズマカッター

- EASYCUT 25
- EASYCUT 40
- CUTTER 30 FV
- CUTTER 45 FV



INDUCTION - インダクション

- GYSDUCTION AUTO
- COMBIDUCTION POWERDUCTION
- 37 LG
- 39 LG
- 50 LG
- 110 LG
- 160 LG



BSU & CHARGERS

BATTERY SUPPORT UNIT



A FULL RANGE FOR ALL NEEDS



DOWNLOAD CATALOGUE



INDIAN CAR MANUFACTURER APPROVALS / COMPLIANCE

INDIAN HOMOLOGATIONS



	OEM - CARS										OEM - TRUCKS			
DENT PULLER	GYSLOT 39.02	•	•	•	•	•	•	•	•	•	•	•	•	•
	SPEEDLINER	•	•	•	•	•	•	•	•	•	•	•	•	•
SPOT WELDERS	GYSLOT ALU FV	•	•	•	•	•	•	•	•	•	•	•	•	•
	GYSLOT 32D	•	•	•	•	•	•	•	•	•	•	•	•	•
	GYSLOT BP-MS/LX/LC/LQC	•	•	•	•	•	•	•	•	•	•	•	•	•
MIG/MAG	GYSLOT PTI-s7	•	•	•	•	•	•	•	•	•	•	•	•	•
	CARMIG	•	•	•	•	•	•	•	•	•	•	•	•	•
	T1 GYS AUTO	•	•	•	•	•	•	•	•	•	•	•	•	•
	T3 GYS AUTO	•	•	•	•	•	•	•	•	•	•	•	•	•
PLASMA	NEOPULSE	•	•	•	•	•	•	•	•	•	•	•	•	•
	CUTTER 25K	•	•	•	•	•	•	•	•	•	•	•	•	•
INDUCTION	CUTTER 30FV	•	•	•	•	•	•	•	•	•	•	•	•	•
	GYSDUCTION AUTO	•	•	•	•	•	•	•	•	•	•	•	•	•
BATTERY CHARGERS	•	•	•	•	•	•	•	•	•	•	•	•	•	•
TOOLS & TROLLEYS	•	•	•	•	•	•	•	•	•	•	•	•	•	•

CHARGERS
6 - 12 - 24 - 36 - 48 V

STARTERS & CHARGERS
12 - 24 V

BOOSTERS
6 - 12 - 24 V

TESTERS
12 - 24 V

ACCESSORIES
+



INVEST IN THE FUTURE



French manufacturer
since 1964

2
0
2
3

Car Body Welding Systems

Catalogue Carrosserie
Catalogo Carrozzeria
Karosserie-Schweißtechnik Katalog
Catálogo de Soldadura para Carrocería



LinkedIn
 Youtube
 WeChat
 Facebook
 Instagram

www.gys.fr



GYS FRANCE

HEADQUARTERS

1 rue de la Croix des Landes
CS 54159
53941 Saint-Berthevin - Cedex
Laval - France
Tel +33 2 43 01 23 60
E-mail service.client@gys.fr



ZI, 134 bd des Loges
53941 Saint-Berthevin
Laval - France

LOGISTIC CENTER

2 Rue Jean Dausset
53810 Changé - France
Tel +33 2 43 01 54 33



GYS GERMANY

Professor-Wieler
Straße 11
52070 Aachen
Deutschland

Tel +49 241/189-23-710
Fax +49 241/189-23-719
E-mail aachen@gys.fr



GYS UK

Unit 3 - Great Central Way
Rugby - Warwickshire
CV21 3XH
United Kingdom

Tel +44 1926 338 609
Fax +44 1926 429 764
E-mail uk@gys.fr



GYS ITALIA

Vega - Parco Scientifico
Tecnologico di Venezia
Via Delle Industrie, 25/4
30175 Marghera - VE
Italia

Tel +39 041 53 21 565
E-mail italia@gys.fr



GYS IBÉRICA

Avenida Pirineos 31
Nave 9
San Sebastian de los Reyes
28703 Madrid
España

Tel +34 917 409 790
E-mail iberica@gys.fr



GYS CHINA

Lot N°15
6666 bd Songze
201706 Qingpu
Shanghai
China

Tel +86 6221 4461
Fax +86 5226 0067
www.gys-china.com.cn
E-mail
contact@gys-china.com.cn

MARKETING

Podium de
présentation
- Display
stand
- Podest

PODIUM 1
A : 45 cm
B : 50 cm
C : 50 cm
063204

PODIUM 2
A : 80 cm
B : 50 cm
C : 50 cm
063211

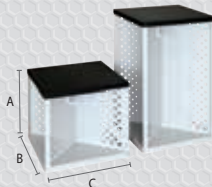

Oriflamme
- Flag
1,75 x 0,50 m
098015

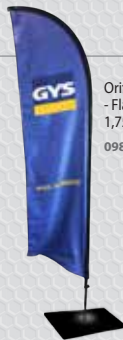

Barnum 3 x 3 m
098022



Open barnum
2 x 2 m
098039



Linéaire de vente
avec 2 étagères
- Retail display
space
with 2 shelves
- Lochwandregal
mit 2 Böden
(machines not
included)
060784

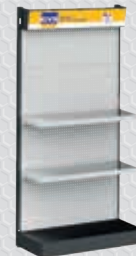

Distributed by

